***TRANSYLVANIAN REVIEW OF
SYSTEMATICAL AND ECOLOGICAL
RESEARCH***

20.1

The Wetlands Diversity

Editors

Angela Curtean-Bănăduc & Doru Bănăduc

**Sibiu – Romania
2018**

TRANSYLVANIAN REVIEW OF SYSTEMATICAL AND ECOLOGICAL RESEARCH

20.1

The Wetlands Diversity

Editors

Angela Curtean-Bănăduc & Doru Bănăduc

“Lucian Blaga” University of Sibiu,
Faculty of Sciences,
Department of Ecology and Environment Protection

Published based mainly on some of the scientific materials presented at the sixth
“Aquatic Biodiversity International Conference” – Sibiu/Romania 2017



ESENIAS
East and South
European network for
Invasive Alien Species



Ecotur Sibiu
N.G.O.



“Lucian Blaga”
University
of Sibiu



**International
Association for Danube
Research**

**Sibiu – Romania
2018**

Scientific Reviewers

John Robert AKEROYD

*Sherkin Island Marine Station,
Sherkin Island – Ireland.*

Doru BĂNĂDUC

*“Lucian Blaga” University of Sibiu,
Sibiu – Romania.*

Alexandru BURCEA

*“Lucian Blaga” University of Sibiu,
Sibiu – Romania.*

Kevin CIANFAGLIONE

*University of Camerino,
Camerino – Italy.*

Angela CURTEAN-BĂNĂDUC

*“Lucian Blaga” University of Sibiu,
Sibiu – Romania.*

Marian-Traian GOMOIU

*Romanian Academy,
Bucharest – Romania*

Thomas HEIN

*Austrian Academy of Sciences, Institute for Limnology,
Mondsee – Austria.*

Oriana IRIMIA-HURDUGAN

*“Alexandru Ioan Cuza” University of Iași,
Iași – Romania.*

Mike JOY

*Te Kura Matauranga o nga Taonga a Papatuanuku Massey University,
Palmerston North – New Zealand.*

Mirjana LENHARD

*Institute for Biological Research,
Belgrade – Serbia.*

Laurisse LUKE

*Australian Rivers Institute, Griffith University,
Nathan, Queensland – Australia.*

Sanda MAICAN

*Romanian Academy Institute of Biology,
Bucharest – Romania.*

Weronika MAŚLANKO

*University of Life Science of Lublin,
Lublin – Poland.*

Pablo del MONTE

*Centro Interdisciplinario de Ciencias Marinas del IPN,
La Paz – México.*

Erika SCHNEIDER-BINDER

*Karlsruhe University, Institute for Waters and River Basin Management,
Rastatt – Germany.*

Teodora TRICHKOVA

*Bulgarian Academy of Sciences, Institute of Zoology,
Sofia – Bulgaria.*

Editorial Assistants

Christelle BENDER

*Poitiers University,
Poitiers – France.*

Cristina-Ioana BRUMAR

*“Lucian Blaga” University of Sibiu,
Sibiu – Romania.*

Alexandru BURCEA

*“Lucian Blaga” University of Sibiu,
Sibiu – Romania.*

Rebecca CLEMOW

*Montana University,
Missula – United States of America.*

Cheryl FULLERTON

*Montana University,
Missula, United States of America.*

Marie-Eve LASSEUR

*Université Claude Bernard Lyon 1
Lyon – France*

Gautier LEROUX

*Campus La Salle St.-Christophe,
Masseube – France.*

Skye MCGINTY

*Montana University,
Missula, United States of America.*

Phyllis MORTON

*Coastal Carolina University,
Conway, South Carolina – United States of America.*

Camille NEVEUX

*University of Bourgogne,
Dijon – France.*

Nathaniel PAGE

*Agricultural Development and Environmental Protection in Transylvania Foundation,
East Knoyle – United Kingdom.*

Skyler PAULI

*Montana University,
Missula, United States of America.*

Skye SUMMERS

*Montana University,
Missula – United States of America.*

Cristopher SEHY

*Montana University,
Missula – United States of America.*

Eduard STAN

*Montana University,
Missula – United States of America.*

Simona STAN

*Montana University,
Missula – United States of America.*

Luciana URSU

*“Lucian Blaga” University of Sibiu,
Sibiu – Romania.*

IN MEMORIAM

Great Union Day **(Romania, 1 December 1918)**

On December 1, 1918, the *National Assembly of Romanians of Transylvania*, consisting of 1,228 elected representatives of the Romanians in Transylvania, Banat, Crişana and Maramureş, convened in Alba Iulia and decreed (by unanimous vote) “the unification of those Romanians and of all the territories inhabited by them with Romania”.

On December 11, 1918, King Ferdinand signed the Law regarding the Union of Transylvania, Banat, Crişana, the Satmar and Maramureş with the Old Kingdom of Romania, decreeing that “The lands named in the resolution of the Alba-Iulia National Assembly of the 18th of November 1918 are and remain forever united with the Kingdom of Romania”.

The Great Union of 1918 was and remains the most sublime event in Romanian history. Its greatness resides in the fact that the fulfilment of the national unity is not the work of any politician, government or party; it is the historic deed of the whole Romanian nation, accomplished out of a powerful longing coming from the vivid awareness of the unity of the people and channelled by the political leaders for it to be led towards its aim with a remarkable political intelligence.

The Great Union was not the result of Romania participating in the war. Neither the supporters of the Entente, nor those of the Central Powers did take into account the Russian revolution or the disintegration of the Austro-Hungarian monarchy. Their reasoning followed the traditional formula of the power relations between states: the victory of the Entente would bring back to Romania Bucovina, Transylvania and the Banat, while the victory of the Central Powers would bring back Bessarabia; one victory excluded the other so that no one could see how all these provinces could join the borders of the Old Kingdom simultaneously.

It was not a military victory that laid the foundation of Romania, but the will of the Romanian nation to create for itself the territorial and institutional framework that is the national state.

A historic necessity - the nation has to live within a national state - proved to be more powerful than any government or party, guilty of selfishness or incompetence and, putting the nation into motion, gave it that huge drive to overcome all the adversities and make its dream come true: the national state.

Florin Constantiniu
A Sincere History of the Romanian People

The Editors

CONTENTS

Preface; <i>The Editors</i>	
Statistical mapping and 3-D surface plots in phytoplankton analysis of the Balkhash Lake (Kazakhstan); <i>Elena KRUPA, Sophia BARINOVA, Lyubov PONAMAREVA and Vyacheslav TSOY</i>	1.
Reproductive ecology of <i>Aegialitis rotundifolia</i> Roxb., a crypto-viviparous mangrove plant species in Krishna Mangrove Forest, Andhra Pradesh; <i>Jacob Solomon Raju ALURI and Henry Jonathan KARYAMSETTY</i>	17.
Mollusc diversity al Pulicat Lagoon (India); <i>Ravichandran RAMANIBAI and Sivalingam GOVINDAM</i>	31.
Antioxidant system of rapans under the action of copper ions and anionic detergent; <i>Oksana ERSHOVA, Valentin TOPTIKOV, Tatyana LAVRENYUK, Oleg KOVTUN and Vladlen TOTSKY</i>	43.
A review of length-weight relationships of freshwater fishes in Malaysia; <i>Amonodin MOHAMAD RADHI, Mohd-Fadzil NURUL FAZLINDA, Mohammad Noor Azmai AMAL and Hashim ROHASLINEY</i>	55.
Upper Caraş River (Danube Watershed) fish populations fragmentation – technical rehabilitation proposal; <i>Răzvan VOICU, Doru BĂNĂDUC, Lee BAUMGARTNER, Liliana VOICU and Angela CURTEAN-BĂNĂDUC</i>	69.
The human impact and the aquatic biodiversity of lake Bosomtwe: renaissance of the cultural traditions of Abono (Ghana)? <i>Dickson ADOM</i>	87.

Preface

In a global environment in which the climate changes are observed from few decades no more only through scientific studies but also through day by day life experiences of average people which feel and understand already the presence of the medium and long-term significant change in the “average weather” all over the world, the most common key words which reflect the general concern are: heating, desertification, rationalisation and surviving.

The causes, effects, trends and possibilities of human society to positively intervene to slow down this process or to adapt to it involve a huge variety of approaches and efforts.

With the fact in mind that these approaches and efforts should be based on genuine scientific understanding, the editors of the *Transylvanian Review of Systematical and Ecological Research* series launch three annual volumes dedicated to the wetlands, volumes resulted mainly as a result of the *Aquatic Biodiversity International Conference*, Sibiu/Romania, 2007-2017.

The term wetland is used here in the acceptance of the Convention on Wetlands, signed in Ramsar, in 1971, for the conservation and wise use of wetlands and their resources.

Marine/Coastal Wetlands – Permanent shallow marine waters in most cases less than six metres deep at low tide, includes sea bays and straits; Marine subtidal aquatic beds, includes kelp beds, sea-grass beds, tropical marine meadows; Coral reefs; Rocky marine shores, includes rocky offshore islands, sea cliffs; Sand, shingle or pebble shores, includes sand bars, spits and sandy islets, includes dune systems and humid dune slacks; Estuarine waters, permanent water of estuaries and estuarine systems of deltas; Intertidal mud, sand or salt flats; Intertidal marshes, includes salt marshes, salt meadows, saltings, raised salt marshes, includes tidal brackish and freshwater marshes; Intertidal forested wetlands, includes mangrove swamps, nipah swamps and tidal freshwater swamp forests; Coastal brackish/saline lagoons, brackish to saline lagoons with at least one relatively narrow connection to the sea; Coastal freshwater lagoons, includes freshwater delta lagoons; Karst and other subterranean hydrological systems, marine/coastal. **Inland Wetlands** – Permanent inland deltas; Permanent rivers/streams/creeks, includes waterfalls; Seasonal/intermittent/irregular rivers/streams/creeks; Permanent freshwater lakes (over eight ha), includes large oxbow lakes; Seasonal/intermittent freshwater lakes (over eight ha), includes floodplain lakes; Permanent saline/brackish/alkaline lakes; Seasonal/intermittent saline/brackish/alkaline lakes and flats; Permanent saline/brackish/alkaline marshes/pools; Seasonal/intermittent saline/brackish/alkaline marshes/pools; Permanent freshwater marshes/pools, ponds (below eight ha), marshes and swamps on inorganic soils, with emergent vegetation water-logged for at least most of the growing season; Seasonal/intermittent freshwater marshes/pools on inorganic soils, includes sloughs, potholes, seasonally flooded meadows, sedge marshes; Non-forested peatlands, includes shrub or open bogs, swamps, fens; Alpine wetlands, includes alpine meadows, temporary waters from snowmelt; Tundra wetlands, includes tundra pools, temporary waters from snowmelt; Shrub-dominated wetlands, shrub swamps, shrub-dominated freshwater marshes, shrub carr, alder thicket on inorganic soils; Freshwater, tree-dominated wetlands; includes freshwater swamp forests, seasonally flooded forests, wooded swamps on inorganic soils; Forested peatlands; peat-swamp forests; Freshwater springs, oases; Geothermal wetlands; Karst and other subterranean hydrological systems, inland. **Human-made wetlands** – Aquaculture (e. g., fish/shrimp) ponds; Ponds; includes farm ponds, stock ponds, small tanks; (generally below eight ha); Irrigated land, includes irrigation channels and rice fields; Seasonally flooded agricultural land (including intensively managed or grazed wet meadow or pasture); Salt exploitation sites, salt pans, salines, etc.; Water storage areas, reservoirs/barrages/dams/impoundments (generally over eight ha); Excavations; gravel/brick/clay pits; borrow pits, mining pools; Wastewater treatment areas, sewage farms, settling ponds, oxidation basins, etc.; Canals and drainage channels, ditches; Karst and other subterranean hydrological systems, human-made.

The editors of the *Transylvanian Review of Systematical and Ecological Research* started and continue the annual sub-series (*Wetlands Diversity*) as an international scientific debate platform for the wetlands conservation, and not to take in the last moment, some last heavenly “images” of a perishing world ...

This volume included varied original researches from diverse wetlands around the world.

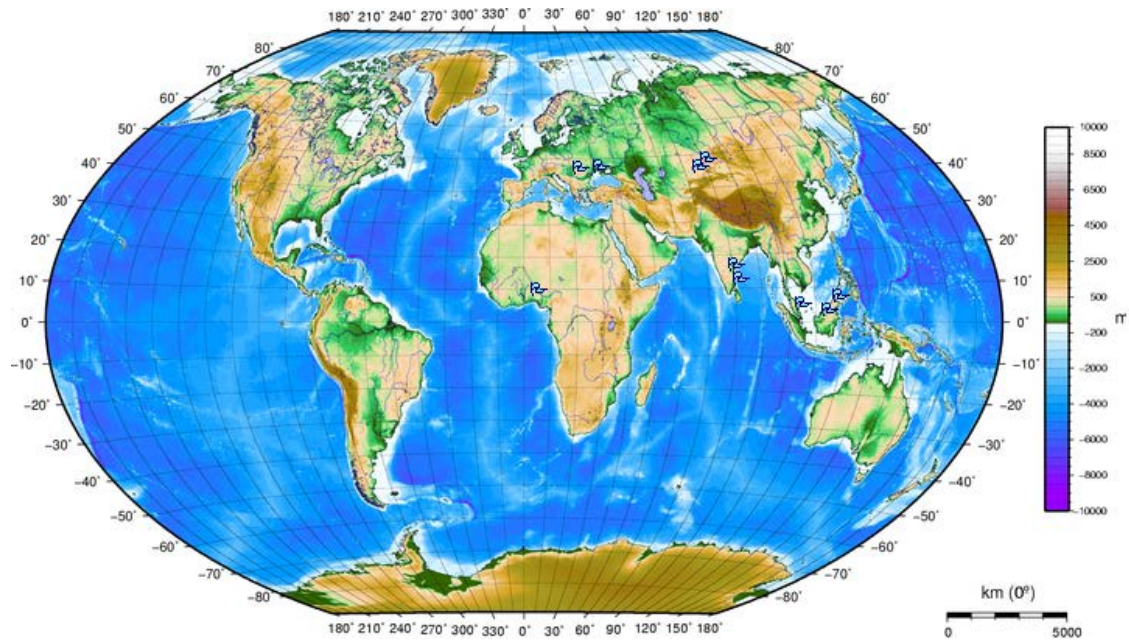

The subject areas (R) for the published studies in this volume.

No doubt that this new data will develop knowledge and understanding of the ecological status of the wetlands and will continue to evolve.

Acknowledgements

The editors would like to express their sincere gratitude to the authors and the scientific reviewers whose work made the appearance of this volume possible.

The Editors

Editorial Office:

“Lucian Blaga” University of Sibiu, Faculty of Sciences, Department of Ecology and Environment Protection, Dr. Ion Rațiu Street 5-7, Sibiu, Sibiu County, Romania, RO-550012, Angela Curtean-Bănăduc (ad.banaduc@yahoo.com, angela.banaduc@ulbsibiu.ro)

(ISSN-L 1841 – 7051; online ISSN 2344 – 3219)

The responsibility for the published data belong to the authors. All rights reserved. No part of this publication may be reproduced or transmitted in any form or by any means, electronic or mechanical, including photocopying, recording or by any information storage and retrieval system, without permission in writing from the Editors of *Transylv. Rev. Syst. Ecol. Res.*

STATISTICAL MAPPING AND 3-D SURFACE PLOTS IN PHYTOPLANKTON ANALYSIS OF THE BALKHASH LAKE (KAZAKHSTAN)

Elena KRUPA *, Sophia BARINOVA **,
Lyubov PONAMAREVA *** and Vyacheslav TSOY ***

* Republican State Enterprise on the Right of Economic Use "Institute of Zoology", Ministry of Education and Science, Science Committee, Almaty, Kazakhstan, KZ-050060, elena_krupa@mail.ru

** University of Haifa, Institute of Evolution, Mount Carmel, Abba Khoushi Avenue 199, Haifa, Israel, IL-3498838, Israel, sophia@evo.haifa.ac.il

*** "Kazakh Research Institute of Fishery" LLP, Zheltoksan Street 20, Balkhash, Kazakhstan KZ-100300, tsoy-balkhash@mail.ru

DOI: 10.1515/trser-2018-0001

KEYWORDS: phytoplankton, structure, spatial dynamics, statistics, Balkhash.

ABSTRACT

Phytoplankton of the Balkhash Lake was represented by 91 species with average abundance of 1,002.4 mln. ind. m^{-3} and average biomass of 0.853 g m^{-3} in summer 2004. Maps of spatial distribution revealed that phytoplankton abundance was confined within the near-estuary sections of the rivers. Correlation analysis and 3D Surface Plots showed that the average mass of the algal cell decreased with increased phytoplankton abundance, species richness, and Shannon Bi index values. Synchronicity of the spatial dynamics of W-Clarke and Δ -Shannon values evidenced the possibility of obtaining information on the structure of communities by both calculated and graphical methods.

ZUSAMMENFASSUNG: Statistische Kartierung und 3-D Darstellung der Oberfläche in einer Phytoplanktonanalyse des Balkhash Sees (Kazakhstan).

Das Phytoplankton des Balkhash-Sees war im Sommer 2004 durch 91 Arten mit einer durchschnittlichen Häufigkeit von 1.002,4 Millionen Individuen pro m^{-3} und einer durchschnittlichen Biomasse von 0,853 g pro m^{-3} vertreten. Karten der räumlichen Verteilung zeigten, dass die Phytoplankton-Abundanz in den nahe der Mündungsbereiche liegenden Abschnitten der Flüsse begrenzt war. Korrelationsanalysen und die 3-D-Oberflächen-Parzellen zeigten, dass die durchschnittliche Masse der Algen-Zellen bei anwachsender Phytoplankton-Abundanz, Artenreichtum und steigenden Werten des Shannon Bi-Index sank. Die Synchronität der räumlichen Dynamik von W-Clarke- und Δ -Shannon-Werten zeigte die Möglichkeit auf, Informationen über die Struktur der Gemeinschaften sowohl aufgrund rechnerischer als auch graphischer Methoden zu erhalten.

REZUMAT: Cartografiere și parcelare de suprafață 3D statistice în analiza fitoplanctonului lacului Balkhash, Kazahstan.

Fitoplanctonul lacului Balkhash a fost reprezentat de 91 de specii cu abundența medie 1.002,4 mln. ind. m^{-3} și o biomasă medie de 0,853 g m^{-3} , în vara anului 2004. Hărți de distribuție spațială au arătat că abundența fitoplanctonului a fost limitată în cadrul secțiunilor în apropierea estuarului râurilor. Analiza corelațiilor și parcelarea de suprafață 3D au arătat că masa medie a celulelor algale a scăzut atunci când a crescut abundența fitoplanctonului, bogăția de specii, și valorile indicelui Shannon Bi. Sincronicitatea dinamică spațială a valorilor Δ -Shannon și W-Clarke a evidențiat posibilitatea de a obține informații cu privire la structura comunităților prin metode calculate și grafice.

INTRODUCTION

The Balkhash Lake (Figs. 1-3) is one of the largest lakes within the arid zone of Kazakhstan (Kudekov, 2002). The rivers Ili, Karatal, Aksu, and Lepsy, that flow into the lake from the south, originate in the mountains of the Tian Shan. The Uzynaral Strait divides the lake into two different parts: the Western Balkhash and the Eastern Balkhash. The Balkhash Lake features an increase of total dissolved solids (TDS) in the direction from west to east (Tarasov, 1961). Increased level of heavy metals in water and soil (Kudekov, 2002) is caused by the presence of ore deposits in the region (Mazurov, 2005) as well as anthropogenic pollution of the lake (Samakova, 2002).

Regular studies of algal communities in the Balkhash Lake have been carried out since 1971 (Abrosova, 1973; Kudekov, 2002; Ponomareva et al., 2005; Krupa et al., 2013, 2014a, 2014b). There is information on species composition, average values of quantitative parameters, as well as the interannual dynamics of the phytoplankton biomass in the previously published references.

The spatial distribution of phytoplankton is of particular interest besides the long-term variability. In large water bodies such as Balkhash Lake, it depends on many external factors. The correlation analysis does not reveal the connection or, alternatively, shows inconsiderable links between biotic and environmental parameters with their wide amplitude and multidirectional influence on aquatic organisms.

One of the informative methods of analysis is data mapping and the 3D Surface Plots construction. Both of these methods allow us to describe the nonlinear nature of variability of biotic parameters within the gradient of controlling factors along identifying coordinates of revealed concentration of aquatic organisms. Coherent changes in biota as an adaptive response to environmental conditions (Barinova and Nevo, 2012) also necessitates the analysis of internal links between the structural variables of communities. In particular, one of the debatable issues concerns the variability of size parameters and diversity of aquatic communities that expressed by the Shannon index within the gradient of external factors (Andronikova, 1996; Protasov and Pavlyuk, 2004; Penning et al., 2008). In this regard, the purpose of this work is to analyze spatial distribution of phytoplankton across the Balkhash Lake surface and to reveal the relationships between structural parameters of communities and environmental variables based on statistical mapping and 3D Surface Plots.

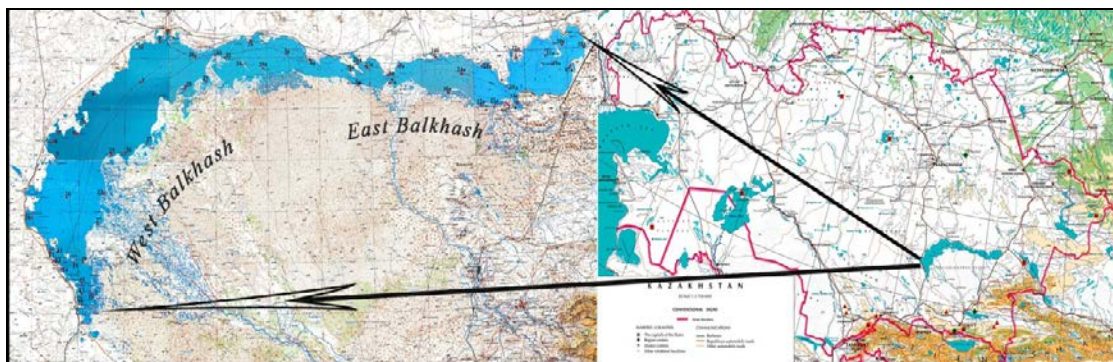

Figure 1: Map sampling stations at Balkhash Lake.



Figure 2: Balkhash Lake.



Figure 3: Balkhash Lake.

MATERIAL AND METHODS

The phytoplankton research, Total Dissolved Solids (TDS), ionic water composition, content of biogenic elements and heavy metals in the water was carried out by means of a grid of 58 stations (Fig. 1) in June-July 2004. The temperature and pH values of the surface water layers were taken in the field environment. Water transparency was measured with Secchi disk. Coordinate referencing of the stations was done by Garmin eTrex GPS-navigator. The samples for heavy metals were fixed in the site by adding nitric acid; samples for biogenes were fixed with chloroform. All collected samples were transported to the lab in an icebox.

Chemical water variables were identified with help of methods in handbooks (Semenova, 1977; Fomin, 1995) in three – four repetitions. The standard error for major ions was 0.5-5.0%, depending on the element. Inductively coupled plasma Mass spectrometer Agilent 7500 A manufactured by Agilent Technologies, USA (National Standard RK ISO 17294-2-2006) was used for the heavy metal analysis, with Abundance Sensitivity for Low Mass $< 5 \times 10^{-7}$, and High Mass $< 1 \times 10^{-7}$.

The phytoplankton samples were calculated with sediment gravimetric method (Kiselev, 1956). Species were identified with help of handbooks for relevant divisions (Zabelina et al., 1951; Gollerbach et al., 1953; Popova, 1955; Palamar-Mordvintseva, 1982; Moshkova and Gollerbach, 1986). Shannon index was calculated in Primer 5 program as the logarithm with base 2 for total number of individuals (Shannon Ab, bit/individual) and for biomass (Shannon Bi, bit/mg) (Magurran, 1998). The arithmetic difference between the two versions of the index (Δ -Shannon) was calculated. The Δ -Shannon was represented by us in first for the plankton communities of the Kolsay mountain lakes (Krupa and Barinova, 2016). Domination Curves were calculated in Primer 5 program. W-statistic of Clarke was calculated automatically (Clarke, 1990). Its value indicates the position of the biomass curve relative to the abundance curve. A positive W value indicates that the biomass curve is higher than abundance curve, and vice versa. The average algal cell mass was calculated as ratio between the total biomass and the total abundance in phytoplankton sample.

The innovative approaches was 3D Surface Plots' construction and statistically generated wafer maps using the Statistica 12.0 program for analysis of biological and environmental variables' relationship.

RESULTS

Environmental variables.

The Western Balkhash depth was about 4.3 m in average, transparency about 0.5 m, water temperature up to 23.5°C, pH values about 8.52, overgrowth by soft macrophytes was 28.3%, by hard macrophytes about 18.0% during the study period. The Eastern Balkhash was deeper with 6.86 meters in average, water transparency up to 1.7 m, temperature about 24.8°C, and pH value about 8.74. Soft and hard macrophytes occupied on average 22.0% and 22.14% of the water area of eastern part of the lake, respectively.

TDS of water in the Eastern Balkhash was statistically significantly higher than in the western part (Tab. 1). Sulphates and sodium prevailed in the ionic composition of water. Higher concentrations of nitrates, nitrites, iron, zinc, and copper were found in the Western Balkhash. Phosphates, cadmium, lead, nickel, and cobalt were present in large quantities in the Eastern Balkhash. The ammonium ions content did not differ in the both parts of the lake.

Table 1: The Total Dissolved Solids (TDS), nutrient content and toxicants (mg dm^{-3}) in the Balkhash Lake, with standard deviation, summer 2004.

Variable	Whole Balkhash	Western Balkhash	Eastern Balkhash
TDS	$2,286.0 \pm 236.0$	$1,080.3 \pm 83.4$	$3,436.8 \pm 286.7$
NH_4	0.102 ± 0.017	0.103 ± 0.013	0.102 ± 0.033
NO_3	0.945 ± 0.244	1.379 ± 0.410	0.492 ± 0.226
NO_2	0.042 ± 0.011	0.060 ± 0.013	0.024 ± 0.016
P- PO_4	0.017 ± 0.004	0.011 ± 0.003	0.023 ± 0.007
Zn	0.028 ± 0.009	0.039 ± 0.018	0.017 ± 0.002
Cu	0.018 ± 0.003	0.022 ± 0.005	0.013 ± 0.002
Cd	0.0036 ± 0.0002	0.0028 ± 0.0002	0.0044 ± 0.0002
Pb	0.034 ± 0.003	0.021 ± 0.002	0.047 ± 0.004
Ni	0.039 ± 0.001	0.037 ± 0.002	0.042 ± 0.002
Co	0.013 ± 0.001	0.010 ± 0.0005	0.017 ± 0.001

Phytoplankton species richness

Phytoplankton was represented by 91 species, 29 of which were green algae, 26 diatoms, 21 blue-greens, four charophytic, four euglenophytic species, three dinophytic, and one chrysophytic species. Planktonic algae in the Western Balkhash (Fig. 4a) was represented by 74 species mostly Chlorophyta, which was higher than that in the Eastern Balkhash (69), where the basis of species richness was formed by Bacillariophyta. The most frequently encountered species in the Western Balkhash were dinophyte *Peridinium* sp., diatom *Cyclotella meneghiniana* Kützing, and euglenophyte *Trachelomonas* sp. In the Eastern Balkhash, in addition to the last two species, diatom *Navicula* sp., green *Franceia* sp., blue-greens *Snowella lacustris* (Chodat) Komárek and Hindák, *Gomphosphaeria aponina* Kützing and *Gloeocapsa* sp. were widespread. The algal communities were represented usually by no more than 7-15 species. Local outbreaks of species richness of phytoplankton were recorded in the southeastern and southern shores of the lake (Fig. 4b).

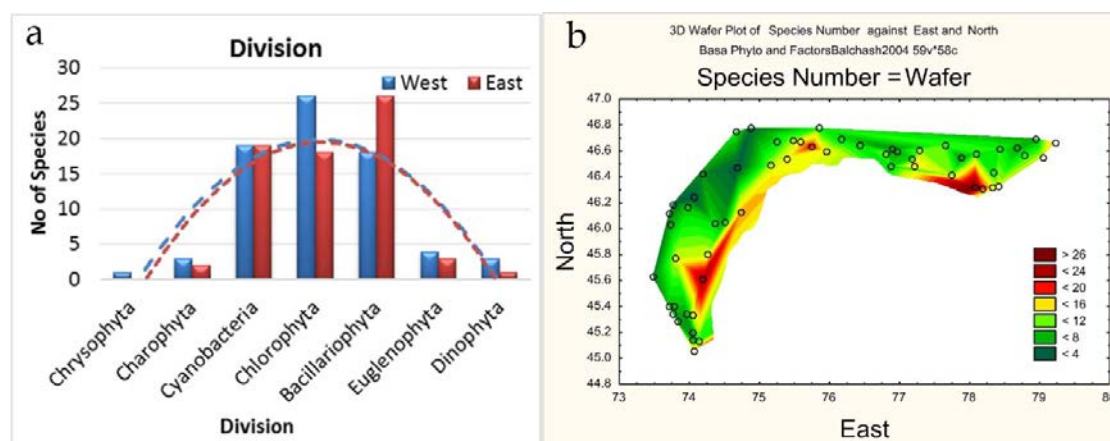

Figure 4: Distribution of species richness of phytoplankton over the taxonomic divisions in the eastern and western parts (a), and across the entire water area (b) of the Balkhash Lake, summer 2004.

Phytoplankton abundance and biomass

The quantitative parameters of phytoplankton were at a lower level in the western freshened part of the water area than in the eastern part (Tab. 2). Cyanobacteria was dominant on average across the lake in both abundance and biomass. Bacillariophyta was subdominant. Euglenophyta was essential in forming total biomass of algae. The proportion of Bacillariophyta in forming the quantitative parameters of the communities increased in the direction from west to east for abundance from 10.1 to 16.5%, and for biomass from 17.6 to 29.1%. The role of Cyanobacteria in community, on the contrary, declined for abundance from 73.9 to 66.0%, and for biomass from 47.6 to 44.6%. There was more pronounced decrease in the eastern direction for Euglenophyta regarding abundance a drop from 7.6 to 6.6%, and for total biomass from 24.9 to 15.2%.

Table 2: Quantitative parameters of phytoplankton of the Balkhash Lake, summer 2004.

Part of the lake	Bacillariophyta	Charophyta	Chlorophyta	Chrysophyta	Cyanobacteria	Dinophyta	Euglenophyta	Total
Abundance, mln. ind. m ⁻³								
Western Balkhash	87.0	6.0	52.3	2.0	658.4	16.3	67.4	889.5
Eastern Balkhash	186.5	5.7	92.3	0.0	776.1	12.6	46.3	1,119.4
average	135.8	5.6	72.0	1.0	716.2	14.5	57.1	1,002.4
Biomass, g m ⁻³								
Western Balkhash	0.150	0.015	0.039	0.004	0.353	0.020	0.211	0.796
Eastern Balkhash	0.243	0.008	0.041	0.000	0.404	0.023	0.093	0.812
average	0.211	0.011	0.043	0.002	0.394	0.022	0.167	0.853

The largest concentrations of plankton algae were confined to the mouths of the flowing rivers (Figs. 5 and 6). The local increases in abundance or biomass of dinophyte, euglenophyte, and blue-green algae were recorded in some parts of the water area. Chrysophyte algae were found only in the western freshwater part of the lake.

Phytoplankton community structure

The diversity of phytoplankton communities was at moderate and elevated levels according to mean values of Shannon Ab and Shannon Bi (Tab. 3). The minimal values of the Shannon index were revealed for the phytoplankton of the western part of the lake, as well as of the deep-water areas of the Eastern Balkhash (Figs. 7a, b). The distribution of algal species over biomass was less even than over abundance, which was reflected in the negative values of Δ -Shannon (Tab. 3). The negative values of W-Clarke indicated that the abundance curve was above the biomass curve, and therefore small-sized species dominated the community. The values of Δ -Shannon and W-statistics of Clarke across the lake area were changing synchronously (Figs. 7c, d).

An average volume of an algal cell varied across the water area by orders of magnitude with its maximal value being in the Western Balkhash (Fig. 7e). The average number of species in a sample and the Shannon Ab and Shannon Bi index values were higher and the average mass of an algal cell was lower in the Eastern Balkhash compared to the western part (Tab. 3). The phytoplankton of the western part of the water area was characterized by a more pronounced shift of Δ -Shannon and W-Clarke towards the negative range in comparison with the Eastern Balkhash.

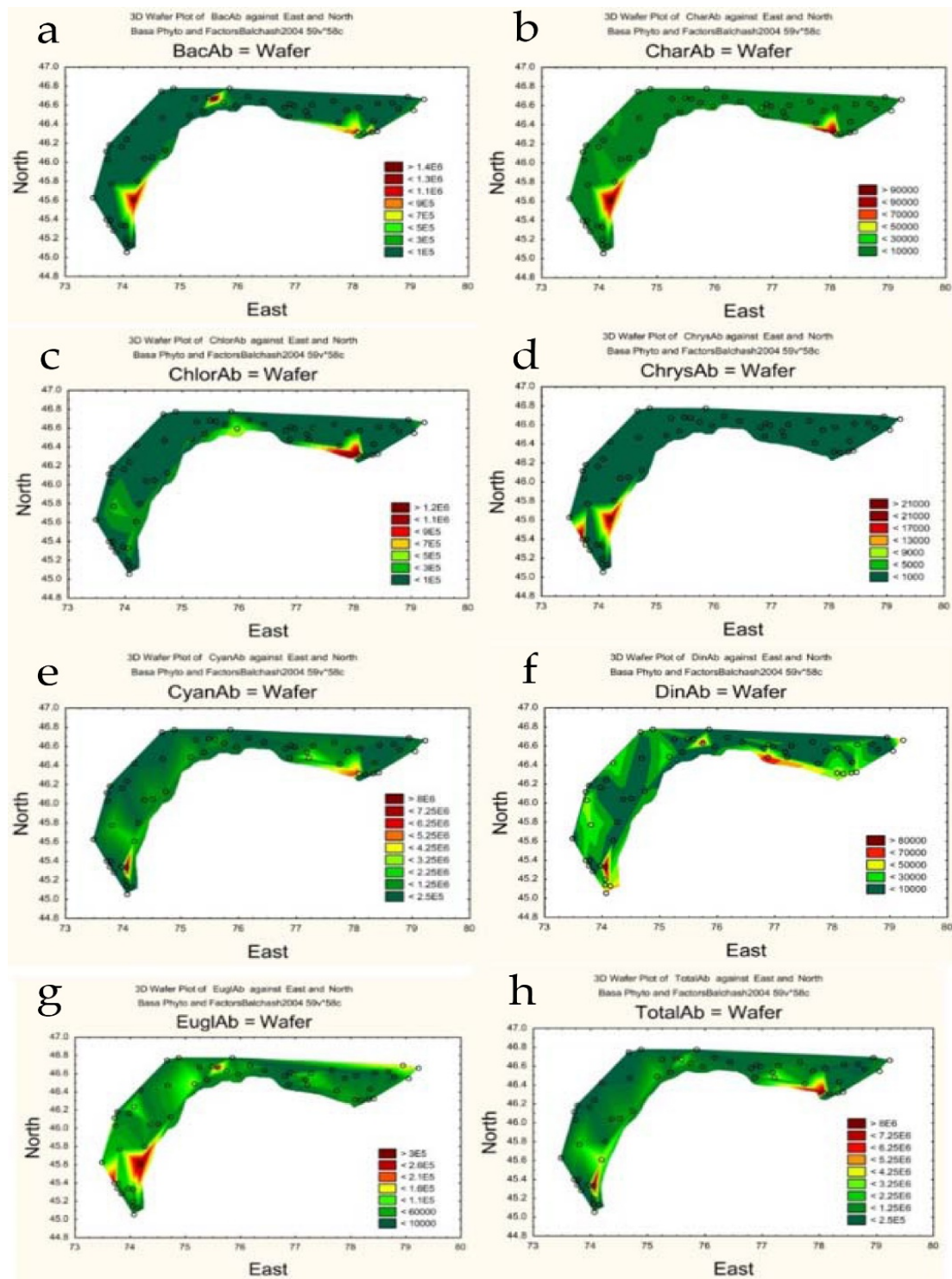

Figure 5: The spatial distribution of the Divisional phytoplankton abundance across the water area of the Balkhash Lake, summer 2004.

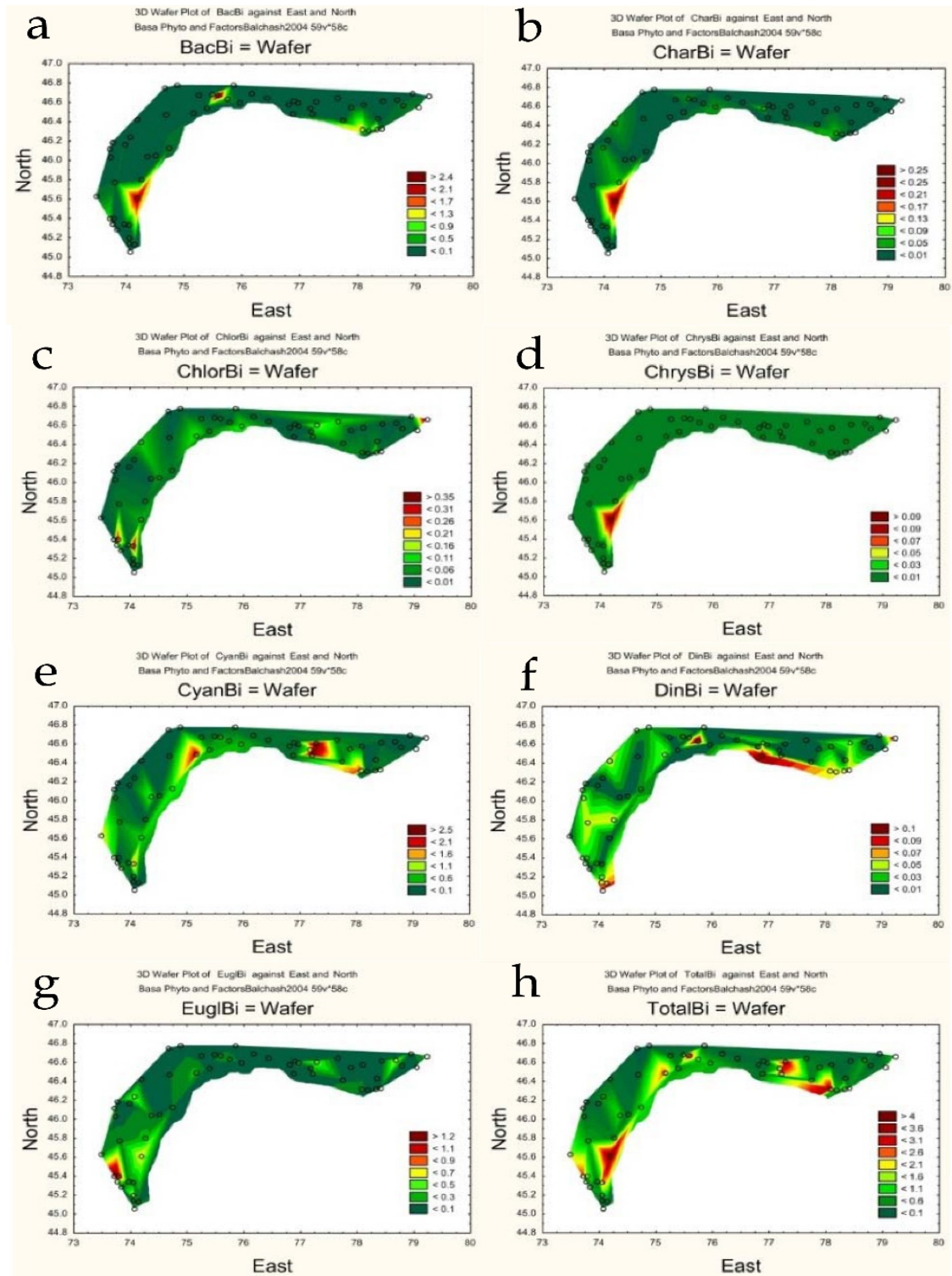

Figure 6: Spatial distribution of the divisional phytoplankton biomass across the water area of the Balkhash Lake, summer 2004.

Table 3: Structural variables of phytoplankton of the Balkhash Lake, summer 2004.

Part of the lake	Species number	Average mass, $\text{mg} \times 10^{-6}$	Shannon AB	Shannon BI	Δ -Shannon	W-Clarke
Western Balkhash	9.1	1.894	2.27	1.91	-0.358	-0.167
Eastern Balkhash	11.7	1.042	2.50	2.35	-0.150	-0.061
average	10.6	1.613	2.40	2.13	-0.270	-0.120

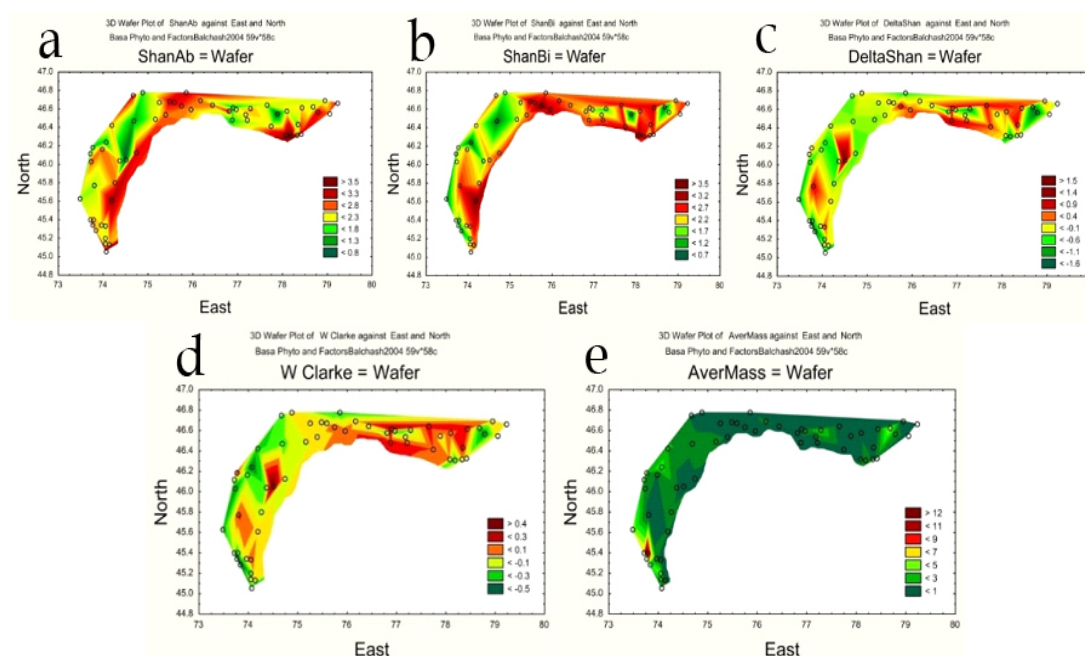

Figure 7: Spatial distribution of structural variables of phytoplankton communities across the water area of the Balkhash Lake, summer 2004.

Correlation analysis (Tab. 4) revealed decreasing of algal cell mass when the phytoplankton total abundance, total biomass, species richness, and the values of Shannon BI and W-Clarke indices increase. A statistically significant but weak relationship between the values of Shannon BI and Shannon AB indicated that these variables were under influence of diverse factors. The Shannon BI index that directly connected to species richness was higher in the small-sized communities, whereas the Shannon AB index was positively correlated with number of species only. Both indices, W-Clarke and Δ -Shannon, having very close positive relationship and showed negative correlation with average cell mass and positive – with Shannon BI.

Table 4: The coefficients of Spearman Rank Order Correlations between phytoplankton structure in Balkhash Lake, summer 2004, $p < 0.05$.

Paired variables	Spearman rank order correlations	Paired variables	Spearman rank order correlations
Total Ab – Δ -Shannon	0.414	Shannon Ab – Δ -Shannon	– 0.373
Total Ab – Average Mass	– 0.532	Shannon Ab – W Clarke	– 0.334
Total Ab – Shannon Bi	0.554	Shannon Bi – species number	0.735
Total Ab – Species number	0.686	Shannon Bi – Average mass	– 0.611
Total Ab – W Clarke	0.450	W Clarke – Δ -Shannon	0.956
Total Bi – Average mass	–	W Clarke – Average mass	– 0.701
Total Bi – Species number	0.448	W Clarke – Shannon Bi	0.623
Total Bi – Total Ab	0.633	Δ -Shannon – Average Mass	– 0.705
Shannon Ab – Shannon Bi	0.426	Δ -Shannon – Shannon Bi	0.636
Shannon Ab – Species number	0.650	Average Mass – Species number	– 0.369

Statistically generated 3-D Surface Plots demonstrated the complex nature of the relationship between various structural variables of phytoplankton. Small-sized algal communities that consisted of the large number of species formed the largest total abundance; abundance of few-species communities was at a lower level and stayed approximately the same within the entire gradient of the cell size parameter (Fig. 8a). Maximal biomass was formed by large-sized communities represented by the largest number of species (Fig. 8b).

The Shannon Ab index values increased almost linearly in multi-species large-size algal communities (Fig. 8c). In contrast, the Shannon Bi values were positively affected by a decrease in the average mass of an algal cell in the multi-species communities (Fig. 8d). The second peak of phytoplankton diversity, which was significantly smaller in absolute values, was revealed in the few-species communities within the entire gradient of the cell size parameter. An almost linear positive relationship between the values of W-Clarke and Δ -Shannon was noted within the gradient of the cell size parameter, with the largest shift of W-Clarke to the region of positive values in small-celled communities. Like Δ -Shannon, W-Clarke values demonstrated close, almost linear connection with both versions of Shannon variety index (Fig. 8f). The values of W-Clarke and Δ -Shannon, close in their positive relationship, were maximal in communities represented by small-celled species within an entire gradient of species richness (Figs. 8g, h). The second, less pronounced W-Clarke extremum was recorded in large-celled communities with medium species richness.

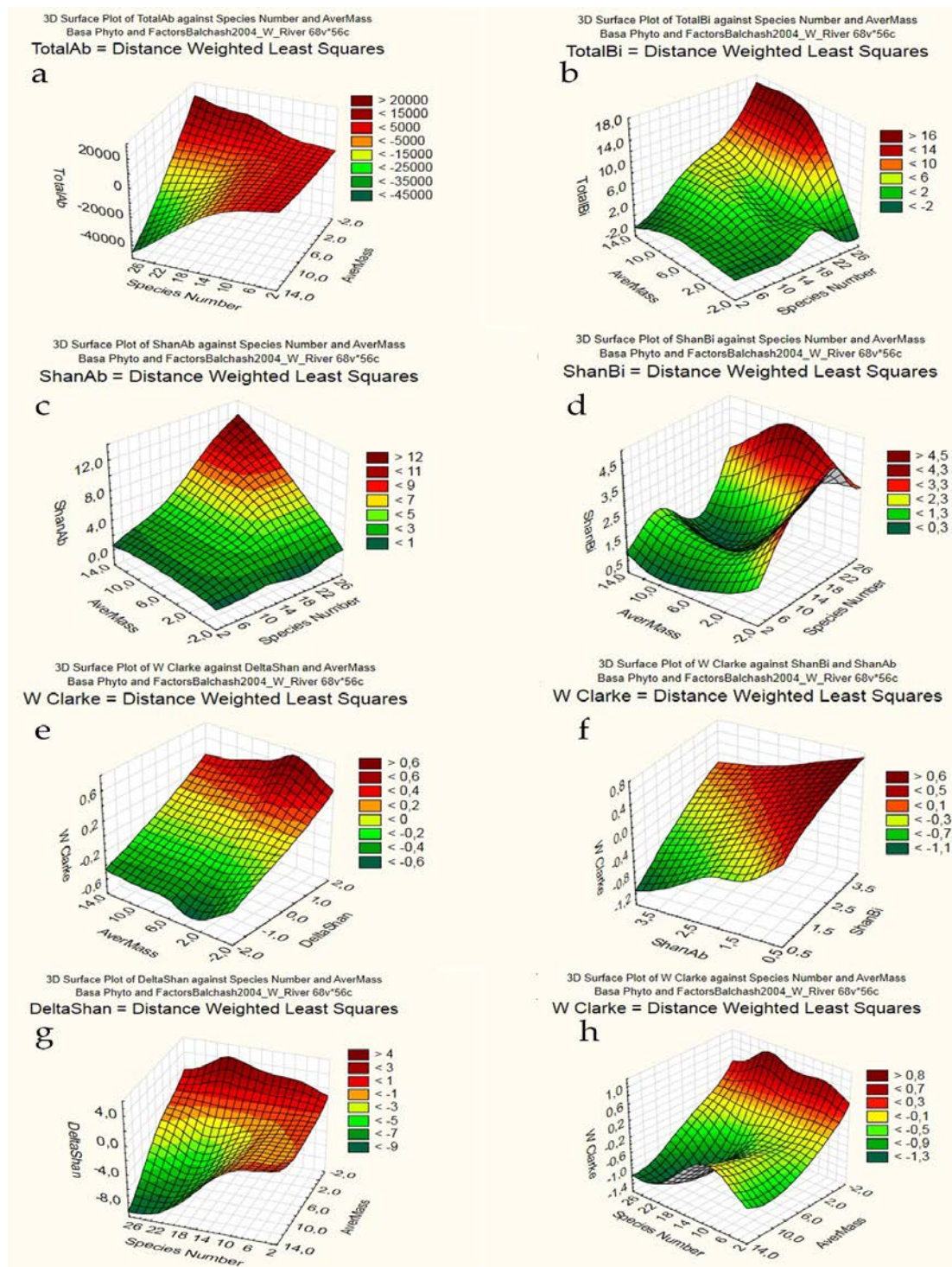

Figure 8: 3-D Surface Plots of structural variables of phytoplankton in the Balkhash Lake, summer 2004.

DISCUSSION

Phytoplankton of the Balkhash Lake was represented by 91 species in summer communities of 2004 with the greatest variety of green, diatom and blue-green algae. The average abundance of plankton algae across the lake was 1,002.4 mln ind. m⁻³ and average biomass was 0.853 g m⁻³. Regarding the biomass of phytoplankton, the Balkhash Lake is more productive than some other large water bodies in the region including the Shardara Reservoir (Barinova and Krupa, 2017a, b) (Tab. 5).

Table 5: Comparative characteristics of structural variables of phytoplankton in some water bodies of Kazakhstan.

Water body	Abundance, mln. ind. m ⁻³	Biomass, g m ⁻³	Average mass, mg 10 ⁻⁶	Shannon Ab	Shannon BI	Δ-Shannon	W-Clarke
Western Balkhash	889.5	0.796	1.894	2.27	1.91	-0.358	-0.167
Eastern Balkhash	1,119.4	0.812	1.042	2.50	2.35	-0.150	-0.061
*Lower Kolsay	510.2	0.226	0.442	2.16	2.61	0.450	-0.077
*Middle Kolsay	75.0	0.451	6.009	2.38	1.94	-0.440	0.127
*Upper Kolsay	110.1	0.477	4.335	2.67	2.25	-0.420	0.136
*Sary-Bulak	11.7	0.078	6.692	2.24	1.14	-1.100	0.610
**Shardara	544.0	0.626	1.660	3.80	3.41	-0.380	-0.095

Note: *Krupa et al., 2016^a, b; **Barinova and Krupa, 2017a, b.

Quantitative parameters of phytoplankton show lower values in the freshwater Western Balkhash compared to the eastern saline part of the water area (Tab. 2) due to the controlling impact of the bivalve mollusk *Monodacna colorata* (Eichwald, 1829; Krupa et al., 2013) that feeds on protozoans, organic substances, bacteria and planktonic algae (Alimov, 1981). Sharp decrease in the total biomass of algae in the western part of the water area has been observed according to our data (Krupa et al., 2013) since 1996 when the biomass of macrozoobenthos, due to the mollusk, reached unprecedented values for the Balkhash Lake up to 14-50 g m⁻². Reorganization of the benthic community structure, in turn, has been caused by a reduction of the commercial stock of benthic fish, primarily carp, whose population due to its disruption is mainly represented by specimens of younger ages (Kenzhebekov et al., 2011).

Mapping of measured data revealed concentration of plankton algae in the areas near mouths of inflowing rivers as well as in the shallows of the Eastern Balkhash. The relationship between the abundance of planktonic algae and river runoff is natural since most of the nutrient elements enter the lake with the waters of rivers and therefore the near-mouth areas are freshened. We earlier (Krupa and Barinova, 2016) noted the confinement of phytoplankton to the shallow-water areas that are influenced by the river runoff.

Very important is the size structure parameters among characteristics of communities, which in integral form reflect the ratio of the species in different ecological groups. Comparative analysis showed (Tab. 5) that the phytoplankton of the Balkhash Lake is represented by smaller species than in the algal communities of the mountain lakes Middle

Kolsay, Upper Kolsay, Sary-Bulak (Krupa and Barinova, 2016). We revealed similar values of the cell size parameter for algal communities of the Shardara Reservoir (Barinova and Krupa, 2017a, b). The smallest-size community was exhibited by phytoplankton of the mountain lake Lower Kolsay, which is associated with its eutrophication against the backdrop of a decrease of the water level (Krupa et al., 2016a, b).

Changes in size parameters that accompanied by other rearrangements in the structure of community were reflected in the values of W-Clarke and Shannon diversity index. The values of the former indicator were positive only for large-sized phytoplankton communities of the Kolsay Lakes (Tab. 5). The diversity of phytoplankton of the Balkhash Lake compared to other water bodies was moderate according to the values of the indices Shannon Ab and Shannon Bi.

The 3-D Surface Plots illustrated an internal relationship between diverse structural parameters of phytoplankton communities of the Balkhash Lake. The total abundance of planktonic algae that represented by a small number of species was at a low level within the entire gradient of size parameter. Higher abundance of algal communities that consist of a large number of small-cell species corresponded with a general principle of successive development of aquatic ecosystems (Odum, 1986). Large-size communities that were also represented by the largest number of species formed maximal biomass. The values of Shannon Ab index increased almost linearly in multi-specific large-size algal communities. In contrast, Shannon Bi values were positively affected by a decrease in the average mass of an algal cell in multi-specific communities. The second peak of phytoplankton diversity, which was smaller in absolute values, was revealed in the few-specific communities within the entire gradient of the cell size parameter. That is, the values of the diversity index of Shannon Ab and Shannon Bi depended on the species richness, but species in the small-sized communities were more evenly distributed according to their biomass. A negative relationship between Shannon Bi index and algal cell size parameters of plankton communities was noted earlier for other water bodies in the region (Krupa, 2012; Krupa and Barinova, 2016; Barinova and Krupa, 2017a, b).

The values of Δ -Shannon and W-Clarke were in close connection with each other as well as with Shannon Bi and Shannon Ab maximizing in communities represented by small-sized species. A strong statistically significant relationship between Δ -Shannon and W-Clarke was found for the phytoplankton communities of diverse water bodies in Kazakhstan such as the Kolsay Lakes (Krupa and Barinova, 2016) and the Shardara Reservoir (Barinova and Krupa, 2017a, b).

The obtained results allow us to conclude that the introduced index Δ -Shannon along with W-Clarke can both be illustrative of the community structure assessment. The average mass of an algal cell, Δ -Shannon, and W-Clarke values are closely related but described the structure of hydrocoenosis from different point of view. There is the need not only for further studies on the variability of structural parameters within the gradient of external factors, but also the analysis of relationships within the communities of hydrobionts. The statistical data mapping can serve as a valuable addition to correlation analysis methods that reveal only linear relationships between the variables. Statistically generated maps have some prognostic properties that together with the three-dimensional graphs allow us to describe the non-linear variability of the dependent variable within the gradient of controlling factors.

CONCLUSIONS

In the summer of 2004, according to our research, phytoplankton of the Balkhash Lake was represented by 91 species, with the greatest variety of green, diatom and blue-green algae. Average abundance amounted to 1,002.4 mln. ind. m⁻³, and average biomass reached 0.853 g m⁻³. The lower quantitative parameters of phytoplankton were found in the Western Balkhash, which is due to the controlling influence of the bivalve *Monodacna colorata*. Analysis of spatial distribution with by means of statistical maps showed the development of phytoplankton intensified near mouths of the inflowing rivers as well as in the shallows of the Eastern Balkhash. Euglenophyta preferred and Chrysophyta developed in the western freshened part of the water area. The relationship between structural parameters within communities was revealed. The decrease in the average mass of an algal cell occurred against the backdrop of an increase in phytoplankton abundance, species richness, and the values of Shannon Bi and Shannon Ab indices. The Shannon Ab index value depended only on the number of species in the community, whereas Shannon Bi index had a positive relationship with the number of species and a negative relationship with the average cell mass. The maximal values of biomass were formed in large-cell multi-specific communities. The higher abundance of algal communities of small-celled species corresponded to the overall change in phytoplankton structure due to eutrophication. The synchronicity of spatial dynamics of the W-Clarke and Δ-Shannon values evidenced the possibility of obtaining information on the dimensional structure of hydrocoenosis both calculated and graphical methods.

Data visualization by means of the statistically generated maps and 3D Surface Plots serve as a good addition to the other statistical analysis methods, as it allows capturing non-linear relationships between variables, including links within biotic communities.

ACKNOWLEDGEMENTS

The work was carried out partly under the project no. 1846/ΓΦ4 Γ.2015-Γ2016 for Committee of Science, Ministry of Education and Science, Republic of Kazakhstan “Development of the methods for controlling the ecological state of water bodies in Kazakhstan”, “Study of the modern hydroecological state of fishery water reservoirs and development of biological justifications for the purposefulness and priority of fishery reclamation for conservation and enhancement of the fishery potential of the reservoir” as well as partly supported by the Israeli Ministry of Absorption.

REFERENCES

1. Abrosov V. N., 1973 – Lake Balkhash, Leningrad, Russia, *Science*, 181. (in Russian)
2. Alimov A. F., 1981 – Functional ecology of bivalve mollusks, *Proceedings of the Zoological Institute of the Academy of Sciences of the USSR*, 96, Leningrad, Russia, Leningrad Branch, 248. (in Russian)
3. Andronikova I. N., 1996 – Structurally and functional organization of zooplankton of lake ecosystems of different trophic types, Saint Petersburg, Russia, *Science*, 189. (in Russian)
4. Barinova S. and Nevo E., 2012 – Algal diversity of the Akko Park wetlands in the Bahai Gardens (Haifa, Israel), *Transylvanian review of Systematical and Ecological Research*, 14, *The Wetlands Diversity*, 55-80.
5. Barinova S. and Krupa E., 2017a – Bioindication of Ecological State and Water Quality by Phytoplankton in the Shardara Reservoir, Kazakhstan, *Environment and Ecology Research*, 5, 73-92.
6. Barinova S. and Krupa E., 2017b – Critical environmental factors for photosynthetic organisms of the Shardara reservoir, Kazakhstan, *Asian Journal of Microbiology, Biotechnology and Environmental Sciences*, in press.

7. Clarke K. R., 1990 – Comparison of dominance curves, *Journal of Experimental Marine Biology and Ecology*, 138, 143-157.
8. Fomin G. S., 1995 – Water. Control of chemical, bacterial and radiation safety according to international standards, Moscow, Russia, NGO "Alternative", 618. (in Russian)
9. Gollerbach M. M., Kossinskaya E. K. and Polyansky V. I., 1953 – Key to freshwater algae of USSR, 2, Blue-green algae, Moscow, Russia, 654. (in Russian)
10. Kenzhebekov B. K., Asylbekova S. Z., Isbekov K. B. and Anurieva A. N., 2011 – Dependence of number of individual fish species in lake Balkhash on abiotic factors, *Water resources and their rational use. Bulletin of the Agrarian Technical University, Fisheries*, 2, 3-17. (in Russian)
11. Kiselev I. A., 1956 – Methods of study of plankton, in *Life of freshwaters of the USSR*, 4, Moscow, Leningrad, Russia, 183-265. (in Russian)
12. Krupa E. G., 2012 – Zooplankton of limnetic and running water ecosystems in Kazakhstan. Structure, forming patterns, Saarbrücken Palmarium Academic Publishing, 346. (in Russian)
13. Krupa E. G., Tsoi V. N., Lopareva T. Y., Ponomareva L. P., Anureva A. N., Sadyrbaeva N. N., Asylbekova S. J. and Isbekov K. B., 2013 – Long-term dynamics of aquatic organisms of the Balkhash Lake and its relationship with environmental factors, *Bulletin of the Astrakhan State Technical University*, 2, 85-96. (in Russian)
14. Krupa E., Slyvinskiy G. and Barinova S., 2014a – The effect of climatic factors on the long-term dynamics of aquatic ecosystem of the Balkhash Lake (Kazakhstan, Central Asia), *Advanced Studies in Biology*, 6, 3, 115-136.
15. Krupa E. G., Sadyrbaeva N. N., Ponomareva L. P., Anurieva A. N. and Assylbekova S. Z., 2014b – The long-term variability of phytoplankton, zooplankton and macrozoobenthos in the lake Balkhash, *Bulletin of the Kazakh National University*, 1/1, 40, 296-304. (in Russian)
16. Krupa E. G. and Barinova S. S., 2016a – Environmental Variables Regulating the Phytoplankton Structure in High Mountain Lakes, *Research Journal of Pharmaceutical, Biological and Chemical Sciences*, 7, 4, 1251-1261.
17. Krupa E. G., Barinova S. M., Romanova S. M. and Malybekov A. B., 2016b – Hydrobiological assessment of the high mountain Kolsay Lakes (Southeastern Kazakhstan) ecosystems in climatic gradient, *British Journal of Environment and Climate Change*, 6, 4, 259-278.
18. Kudekov T. K. (ed.), 2002 – The modern ecological state of the basin of lake Balkhash, Almaty, Kazakhstan, Kaganat, 386. (in Russian)
19. Magurran E., 1998 – Ecological diversity and its measurement, Moscow, Mir, 184. (in Russian)
20. Mazurov A. K., 2005 – Metallogenic zoning of Kazakhstan, *Proceedings of Tomsk Polytechnic University*, 308, 4, 33-39. (in Russian)
21. Moshkova N. A. and Gollerbach M. M., 1986 – Key to freshwater algae USSR, 10, 1, Green algae, Class Ulothrichophyceae, Moscow, 361. (in Russian)
22. Odum E., 1986 – Ecology, Moscow, Russia, World, 376. (in Russian)
23. Palamar-Mordvintseva G. M., 1982 – Key to freshwater algae USSR, 11, 2, Green algae, Class Conjugatophyceae, Desmidiaceae (2), Moscow, Russia, 621. (in Russian)
24. Penning W. E., Mjelde M., Dudley B., Hellsten S., Hanganu J., Kolada A., van den Berg M., Poikane S., Phillips G., Willby N. L. and Ecke F., 2008 – Classifying aquatic macrophytes as indicators of eutrophication in European lakes, *Aquatic Ecology*, 42, 237-251.
25. Ponomareva L. P., Shaukharbaeva D. S. and Lopareva T. Y., 2005 – Hydrochemical variables and phytoplankton as trophy indicators of the lake Balkhash and Ily River's reservoirs, in *Fisheries research in the Republic of Kazakhstan*, Almaty, Kazakhstan, Kaganat, 366-376.
26. Popova T. G., 1955 – Key to freshwater algae USSR, 7, Euglenophyta, Moscow, Russia, 213. (in Russian)
27. Protasov A. A. and Pavlyuk T. E., 2004 – Use of biodiversity indicators for assessing the state of water bodies and water quality, *Hydrobiological Journal*, 40, 6, 3-17.
28. Samakova A. B. (ed.), 2003 – Problems of hydroecological stability in the basin of lake

- Balkhash, Almaty, Kaganat, Kazakhstan, 584.
29. Semenova A. D. (ed.), 1977 – Guideline for chemical analysis of surface water, Leningrad, Russia, *Gidrometeoizdat*, 541. (in Russian)
 30. Tarasov M. N., 1961 – Hydrochemistry of Balkhash Lake, Moscow, Russia, 233. (in Russian)
 31. Zabelina M. M., Kiselev I. A., Proshkina-Lavrenko A. I. and Sheshukova V. S., 1951 – Key to freshwater algae USSR, 4, Diatoms, Moscow, Russia, 622. (in Russian)

**REPRODUCTIVE ECOLOGY OF *AEGIALITIS ROTUNDIFOLIA* ROXB.,
A CRYPTO-VIVIPAROUS MANGROVE PLANT SPECIES
IN KRISHNA MANGROVE FOREST, ANDRA PRADESH**

Jacob Solomon Raju ALURI * and Henry Jonathan KARYAMSETTY *

* Andhra University, Department of Environmental Sciences, Visakhapatnam, China Waltair Street, India, IN-530 003, solomonraju@gmail.com, khjonathan@gmail.com

DOI: 10.1515/trser-2018-0002

KEYWORDS: Crypto-vivipary, mixed breeding system, melittophily, India.

ABSTRACT

Aegialitis rotundifolia is a hermaphroditic, self-compatible species with mixed breeding system. The floral characters indicate melittophilous pollination syndrome. Field studies indicate this species is melittophilous but anemophily also occurs due to its seaward occurrence where high winds usually prevail. Autogamy and allogamy are functional, and these modes indicate a "fail-safe" strategy for reproductive assurance when con-specifics do not occur nearby. Natural fruit set rate is 55-61%. The seed produces seedling within the fruit pericarp while it is still attached to the parent plant. Seedling or seed dispersal and establishment occurs through self-planting and stranding strategies.

ZUSAMMENFASSUNG: Reproduktionsökologie von *Aegialitis rotundifolia* Roxb., eine krypto-vivipare Pflanzenart im Krishna Mangrovenwald von Andhra Pradesh.

Aegialitis rotundifolia ist hermaphroditisch, selbstkompatibel mit einem gemischten Vermehrungssystem. Die floralen Kennzeichen weisen auf eine Neigung zu melittophiler Bestäubung hin. Feldstudien belegen diese Art als melittophil, aber es kann aufgrund ihres See seitigen Vorkommens, wo meist starke Winde vorherrschen auch anemophile Bestäubung stattfinden. Autogamie und Allogamie sind funktional und belegen eine "absolut sichere" Strategie für die Gewährleistung der Fortpflanzung, wenn keine Artgenossen in der Nähe auftreten. Die natürliche Fruchtungsrate beträgt 55-61%. Die Samen produzieren Keimlinge innerhalb der Fruchtwand, während sie noch an der Stammpflanze hängen. Sämling oder Samen Ausbreitung und Etablierung findet durch Selbstpflanzung und Grundberührung statt.

REZUMAT: Ecologia reproducerii speciei *Aegialitis rotundifolia* Roxb., o plantă cripto-vivipară în pădurea de mangrove Krishna de la Andhra Pradesh.

Aegialitis rotundifolia este o specie hermafrodită, auto-compatibilă cu sistem mixt de reproducere. Caracterele florale indică sindromul de polenizare melitofilă. Studii de teren indică însă faptul că această specie este melitofilă, polenizarea efectuându-se și prin anemofilie datorită creșterii sale la marginea dinspre mare a mangrovei, unde prevalează în mod obișnuit vânturi puternice. Autogamia și alogamia sunt funcționale și aceste moduri indică o strategie „sigură în caz de avarie” pentru asigurarea reproducerii atunci când condominalele nu se întâlnesc în apropiere. Rata naturală de fructificare este de 55-61%. Semintele produc germeni în pericarpul fructului în timp ce acesta este încă legat de planta mamă. Împrăștierea germenilor sau a semințelor are loc prin strategii de auto-plantare și de aderare la substrat.

INTRODUCTION

Mangroves are one of the most interesting types of ecological systems in the world (Hogarth, 1999; Aziz and Hashim, 2011). Tomlinson (1986) was the first to describe the basic botany of mangroves. Floral biology accounts were based on floristic, biology, ecology, phytogeography, utilization and conservation of mangroves individually or in combination of them. Reproductive ecology studies of mangroves focused primarily on seed biology, especially viviparous and other seedling peculiarities. The study of pollination biology and breeding systems of mangroves in wetlands is a difficult task and hence the descriptions of pollination and breeding systems are almost exclusively based on floral characteristics without much or any experimentation. Chapman (1976) stated that the general opinion about mangroves is that the latter do not support a distinct pollinator fauna and the majority of animal pollinators recorded so far in them either come from the adjoining terrestrial vegetation or are characteristic of saline mud flats irrespective of whether they support a vegetation cover.

The genus *Aegialitis* (belonging to Aegialitiaceae family) is formed of two species, *A. rotundifolia* and *A. annulata*. The first one is present in Burma, Bengal, and the Andaman Islands; it occurs in exposed seaward sites. The second is present in northern Australia and east Malesia, but its characteristic sites of occurrence is not known. There is no information on the reproductive ecology of these two species (Tomlinson, 1986). The present research supply details of the reproductive ecology of *Aegialitis rotundifolia* Roxb. which is present in Krishna mangrove forest, Andhra Pradesh, India. The researched elements have been discussed in the light of main literature.

MATERIALS AND METHODS

The Krishna mangrove forest is located in the Krishna estuary in Krishna and Guntur districts, between 15°42'-15°55'N and 80°42'-81°01'E in the State of Andhra Pradesh, India. The total area of the Krishna mangrove forest is 140 km² (State of Forest Report 2003 by Forest Survey of India, Dehradun, the Government of India). *Aegialitis rotundifolia* is a seaward euhaline crypto-viviparous mangrove plant species in the Krishna mangrove forest. It has a small population, far away from human habitations, and is unknown to locals. Field investigations and experiments were conducted during the period of August 2014 to August 2016.

Observations regarding the organization of inflorescences, the spatial positioning of flowers, and their position (terminal, axillary, etc.) on the trees were made, since these features are regarded as important for foraging and effecting pollination by flower-visitors. Quantification of the number of flowers produced per inflorescence was made. The duration of inflorescence life was determined by tagging 10 inflorescences which have not initiated flowering, selected at random and following them daily, until they ceased flowering permanently.

Anthesis was initially recorded by observing marked mature buds in the field. Later, the observations were repeated three to four times on different days in order to provide accurate anthesis schedule for each plant species. Similarly, the mature buds were followed for recording the time of anther dehiscence. The presentation pattern of pollen was also investigated by recording how anthers dehisced and confirmed by observing the anthers under a 10x hand lens.

The flower morphology details, life-time and relative positions of stamens stigma from mature bud to the fall of flower through flower-opening for the possibility of self or cross-pollination, were examined.

Twenty five mature buds prior anther dehiscence were collected from five plants and kept in a Petri dish. These buds were used for calculating pollen output per anther and flower, pollen-ovule ratio as per Cruden (1977). Pollen was collected again afresh from one hundred flowers, for the estimation of pollen protein content according to method provided by Lowry et al. (1951).

Stock standard of Bovine serum albumin (one mg/ml) was taken and 0.2 mg/ml of working standard was prepared. Serial dilutions of 0.2, 0.4, 0.6, 0.8 and one ml of protein solution were taken and the volume was made to one ml with distilled water. Then, two ml of alkaline copper solution was added to all these five different protein solutions and allowed to stand for 10 minutes. Then, 0.2 ml of Folin-Ciocalteu's phenol reagent was added to each test tube and incubated for 30 minutes at laboratory temperature. A blank was prepared with one ml of distilled water and the absorbance was measured at 660 nm. A standard curve was plotted by taking the protein concentration on X-axis and absorbance on Y-axis.

Ten flowers were used to determine the volume of nectar and it was measured in μ l. Hand Sugar Refractometer was used to determine the nectar sugar concentration. Paper chromatography method of Harborne (1973) was used to carry out analysis of sugar types. The amount of sugar present in the nectar/flower was calculated as per the protocol provided in Dafni et al. (2005). Amino acids present in the nectar were qualitatively recorded using the Paper chromatography method described by Baker and Baker (1973).

The stigma receptivity was tested with hydrogen peroxide from mature bud stage to flower drop as per Dafni et al. (2005). H_2O_2 method described by Dafni et al. (2005) was used to test stigma receptivity duration.

Mature flower buds of some inflorescences on different individuals were tagged and enclosed in paper bags. They were tested in the following way and the number of flower buds used for each mode of pollination was given in the table.

1. The stigmas of flowers were pollinated with the pollen of the same flower manually by using a brush and bagged to observe manipulated autogamy.
2. The flowers were fine-mesh bagged as such without hand pollination to detect spontaneous autogamy.
3. The emasculated flowers were hand-pollinated with the pollen of a different flower on the same plant and bagged to test geitonogamy.
4. The emasculated flowers were pollinated with the pollen of a different individual and bagged to detect xenogamy.
5. The emasculated flowers were kept open without bagging for assessing the role of insects in pollination. Further, mature buds were bagged with coarse-mesh to prevent insects, but to permit wind to assess the role of wind in pollination.

All these categories of flower pollinations were kept under regular observation until fruit set. Then, the percentage of fruit set was calculated for each mode. The flowers/inflorescences were tagged on different individuals prior to anthesis and followed for fruit and seed set rate in open-pollinations. The fruit and hypocotyl length, orientation, colour and other characteristics were also recorded. The importance of fruit pericarp in assisting hypocotyls/fruits for floating in water was also observed.

Foraging insects were observed at the flowers and identified to the extent possible. The insect species that were not identified were caught and identified by tallying the specimens of the study area already identified and deposited in the institution. The foraging visits made by each insect species at each hour on twenty flowering inflorescences were recorded for three consecutive days and the date pooled to calculate the relative percentage of visits made by them per day and total foraging visits made by each insect category per day. Ten specimens of each foraging insect species caught during peak foraging time were examined for the pollen carrying capacity of individual species. Each specimen was immersed and washed in ethyl alcohol and stained with aniline-blue on a glass slide prior to observation under microscope for pollen count. Further, foragers were observed for their flower probing behavior with reference to their role in pollination.

RESULTS

Phenology. It is a soft-wooded evergreen shrub species, growing to three m height, with a basally swollen fluted axis (Fig. 1a). It occurs in association with *Ceriops decandra*, *C. tagal*, *Bruguiera gymnorrhiza* and *Excoecaria agallocha*. Its' leaves excrete salt which, in turn, gets crystallized on the leaf surface on sunny days (Fig. 1b). The flowering occurs from 2nd week of February to 3rd week of April. An individual tree flowers for 20-22 days. The flowers are produced in terminal, irregular, one-sided cymes with pairs of opposite linear bracteoles. An inflorescence produces 6.2 ± 1.6 (Range 4-10) flowers over a period of six or seven days (Fig. 1c).

The Flower. Flowers are pedicellate, small, 18 mm long, 11 mm wide, white, cup-shaped, odourless, bisexual, and zygomorphic. Sepals are five, small, nine mm long, green, united basally and free apically, glabrous, coriaceous, valvate and persistent. Petals are five, alternate to sepals, 12 mm long, white, herbaceous, free above with bluntly rounded lobes, and fused basally to form a corolla tube of three mm long. Stamens are five, 12 mm long, free, and inserted on the corolla tube alternately with the petals. The filaments are seven mm long, whitish, glabrous, slender, forming short hollow tube with a ring of internal and external hairs at the level of the mouth of the corolla tube. The anthers are bilobed, two mm long, inserted, sagittate, introrse and basifixed. Ovary is superior, oblong, one-chambered with a single basally attached anatropous ovule (Fig. 1o, q). It has five grooves each extending into a lobe which in turn extending into a free style (Fig. 1i). The styles are five, free, white, each style 10 mm long with an extended oblique peltate stigma initially facing inward and later facing outward (Fig. 1p).

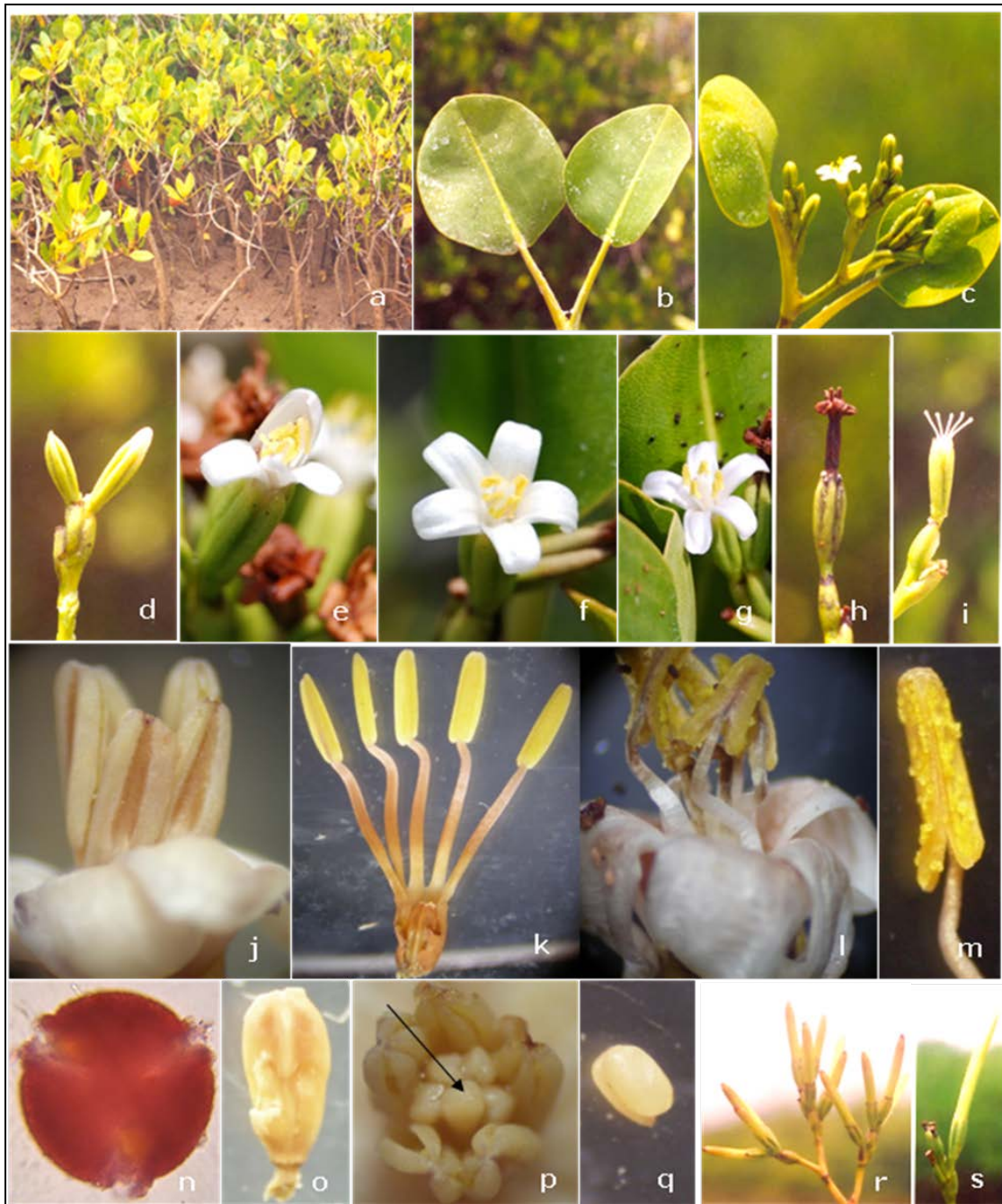

Figure 1: *Aegialitis rotundifolia*: a. Habitat; b. Leaves showing salt excreted from within the system; c. Flowering inflorescence; d. Buds; e-h. Different stages of flower life; i. Ovary with five free styles each terminated with a peltate stigma; j. and k. Undehiscent anthers; l. and m. Dehiscent anthers; n. Pollen grain; o. Ovary; p. Free styles each terminated with a stigma; q. Single ovule; r. and s. Well developed propagules.

Floral biology. The mature buds open at 07.00-09.30 h by slightly unfolding a single petal first, followed by the 2nd petal and other petals within two hours (Fig. 1d-f). Petals reflex backward partially exposing stamens and the styles (Fig. 1g). The styles and stigmas stand slightly below the height of the anthers, face inward at anthesis and diverge gradually moving away from the anthers but reaching closer to the petals. The anthers dehisce by longitudinal slits along with anthesis (Fig. 1j-m). The pollen output per anther is 288.6 ± 40.27 (Range 240-372) and, per flower, is 1,443. Pollen grains are large, spheroidal, tricolporate, characterized by prominent central wart-like sculptures, light yellow, exine rough, thick and 119.52 ± 10.49 μm in size (Fig. 1n). The pollen-ovule ratio is 1,443:1. The pollen protein content per anther is $6.08 \mu\text{g}$ and per flower is $30.04 \mu\text{g}$. Pollen grains are viable for $2^{1/2}$ days. The stigma attains receptivity two hours after anthesis and continues up to the evening of the 3rd day. A flower produces 6.50 ± 0.8 (Range 5-7.8) μl of nectar at the flower base by the time of anthesis. The nectar sugar concentration is $46.2 \pm 5.4\%$ (Range 36-53%) and the common sugars include fructose and glucose which occur in almost equal amounts. There is no significant correlation between nectar volume and sugar concentration ($r = -0.386$ at $p > 0.05$ significance level). The total sugar content in the nectar of a flower is 3.60 ± 0.49 (Range 3.07-4.64) mg. The nectar contains 16 amino acids which include tyrosine, glycine, lysine, aspartic acid, glutamic acid, serine, cysteine, cystine, alanine, threonine, arginine, phenylalanine, proline, tryptophan, valine, and histidine. The relative dominance of these amino acids is given in table 2. The corolla gradually turns from white to dark red from day one to day four. The dark red corolla, together with stamens and styles, remain in place for two to three weeks during which the calyx bulges due to growing fruit inside (Fig. 1h). The calyx is persistent and inseparable from fruit. The flowers not pollinated fall off on the 4th day.

Breeding system. The results of breeding systems indicate that the flowers are self-compatible and self-pollinating. The fruit set is 9% in wind-pollinated flowers, 25% in spontaneous autogamy, 47% in insect-assisted pollination, and 60% in open pollination (Tab. 1). Fruit set per inflorescence in open pollination is 2.62 ± 1.41 (Range 1-7).

Table 1: Results of breeding experiments on *Aegialitis rotundifolia*.

Test	Treatment	Pollen source	No. of flowers/plants	Fruit set (%)
Control	Unbagged	Open pollination	300/30	60
Wind pollination	Coarse-mesh bagged	The same flower or other flowers transported by wind	100/10	9
Spontaneous autogamy	Fine-mesh bagged	The same flower	240/20	25
Insect-assisted cross-pollination	Unbagged, emasculated	Other flowers on the same or different plants	100/10	47

Pollination mechanism and pollinators. The flowers are not specialized, but the sex organs get exposed when the petals partially reflex downwards. Foraging bees consisting of *Apis dorsata*, *A. cerana*, *A. florea* and *Ceratina simillima* collected both pollen and nectar throughout the day (Fig. 2), with more activity during forenoon time effecting pollination. *A. dorsata* and *A. florea* collectively made more than 60% of total foraging visits (Fig. 3). All bee species were found to carry pollen, but the amount of pollen varied with each species (Tab. 2). High winds blow regularly seaside and cause the pollen grains to be released by anthers in air.

Table 2: Pollen carrying capacity of insect foragers of *Aegialitis rotundifolia*.

Insect species	Sample size	Range	Mean \pm S.D.
<i>Apis dorsata</i>	10	132-1,152	658 \pm 316.94
<i>Apis cerana</i>	10	59-147	96.3 \pm 30.35
<i>Apis florea</i>	10	22-184	78.4 \pm 62.6
<i>Ceratina simillima</i>	10	15-42	24.7 \pm 8.65

Fruiting behaviour. Pollinated and fertilized flowers initiate fruit development immediately and take 30-45 days to produce mature fruits. The fruit is an elongated, bluntly pointed one-seeded capsule, light green to brown, 72 ± 4 mm (Range 65-83) long, enveloped basally by persistent calyx, funicular tube attached to seed and enlarging hypocotyl which protrudes from the seed coat but not the pericarp. The seed coat is hard, brown, embryo elongated with an extended hypocotyl. Mature fruit with well developed hypocotyl stands upright (Figs. 1r, s). The fruit pericarp is thin but thickened somewhat distally. It is water-buoyant and dispersed by tidal waters. It detaches along with the quadrangular calyx. The hypocotyls settle at the mother plant if the site is not inundated due to tidal water and float in tidal waters, especially during high tide periods. In fruits that float in tidal waters, the pericarp becomes soft and ruptures longitudinally to expose the hypocotyl to saline water. The hypocotyls devoid of fruit pericarp did not float, while those with it floated. Such hypocotyls float until they find suitable substratum which is sticky and silty mud. The radicle side of hypocotyl penetrates the soil and produces root system while plumule side produces new leaves and subsequent aerial system. In the study area, very few propagules were found to settle, establish and produce new plants.

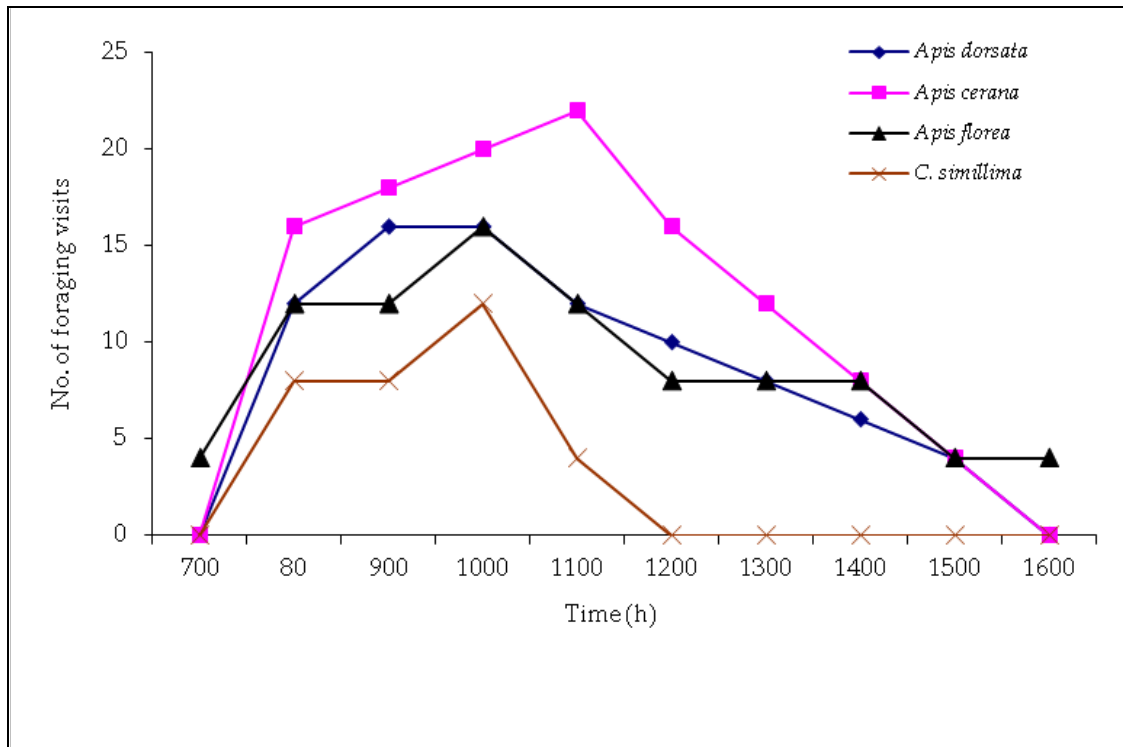

Figure 2: Hourly foraging activity of bees on *Aegialitis rotundifolia*.

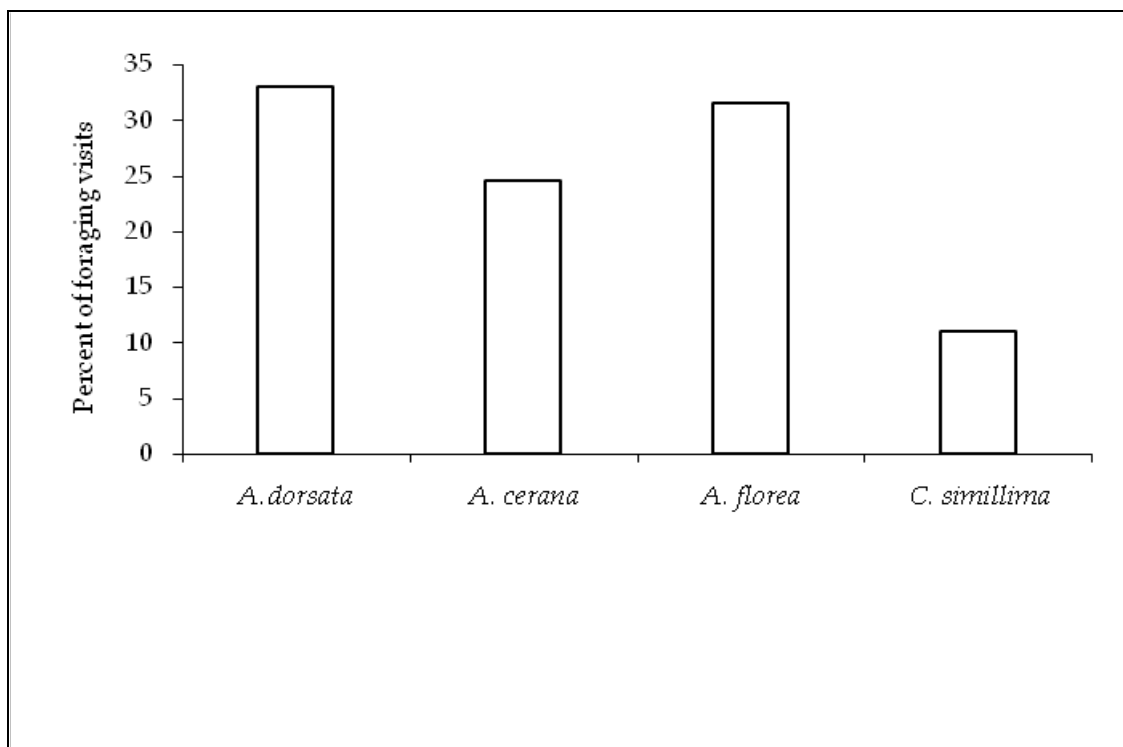

Figure 3: Percentage of foraging visits of bees on *Aegialitis rotundifolia*.

DISCUSSION

Distribution, salt excretion and floral characteristics. The genus *Aegialitis* represents only two shrub species, *A. annulata* and *A. rotundifolia*. It is recently segregated as the family Aegialitidaceae because of some distinctive features from other genera of Plumbaginaceae. Some features include anomalous secondary thickening, abundant sclereids, incipiently viviparous seeds, monomorphic pollen, and homostylous flowers (Weber-El Ghobary, 1984; Tomlinson, 1986). The two species do not occur together in the same forest and have distribution in different parts of the world. *A. annulata* is distributed in Australia and eastern Malaysia (Tomlinson, 1986) while *A. rotundifolia* in South Africa and South-East Asia (Kathiresan and Bingham, 2001). *A. rotundifolia* has been reported to occur in Burma, Bengal and the Andamans by Tomlinson (1986). Later, Naskar and Mandal (1999) reported this species as occurring in the Sundarbans, Andaman and Nicobar Islands and Mahanadi delta of Orissa only. Ramasubramanian et al. (2003) have not mentioned the occurrence of *A. rotundifolia* in their recently published book on the mangrove flora of Krishna and Godavari deltas of Andhra Pradesh. The present study revealed the presence of *A. rotundifolia* in Nachugunta Reserve Forest of Krishna Mangroves in Andhra Pradesh and, hence, it is the first record of *A. rotundifolia* from Andhra Pradesh.

Tomlinson (1986) stated that the *Aegialitis* species prefer or require exposed sites and withstand waves and tidal action. Further, he also mentioned that *A. rotundifolia* does not occur within closed mangrove communities, but it may occur as back mangal if soil is highly saline. Aksornkoae et al. (1992) also reported similarly about the habitat requirements of *A. rotundifolia*. Also, at the study site, this species occurs in seaward, euhaline and exposed sites.

As the habitat of *A. rotundifolia* is highly saline, salt in high concentrations in plant tissues is toxic and hence, must be excluded by some mechanism. The absorbed salt is excreted metabolically via salt glands present on the leaf blade (Scholander, 1968). The salt evaporates or crystallizes in a conspicuous manner on the surface of leathery leaf blades of *A. rotundifolia*. Later, the crystallized salt blows away or washes off during cool period by the absorption of atmospheric moisture and by rain. Therefore, *A. rotundifolia* with salt excretion mechanism is highly specialized to withstand high saline soils.

Naskar and Mandal (1999) reported that the ovary is five-carpelled, syncarpous and stigma is absent in *A. rotundifolia*. But, in the present study, it is found that the ovary is one-chambered, styles five each terminated with an extended oblique peltate stigma as reported by Tomlinson (1986). Weber-El Ghobary (1984) reported that distinct monomorphic pollen is the characteristic feature in this species, and also in *A. annulata*. This study confirms the same.

Pollination biology. The plant is a dry season bloomer but it completes flowering prior to the onset of extreme dry conditions in the month of May. During this period, fluvial discharge from rivers to sea is almost negligible and this would result in increased salinity of seawater. A steep increase in salinity levels can be expected at the site of the plant which is characteristically seaward in occurrence. Increased salinity of seawater reportedly prevents fruiting and causes senescence of immature flowers and buds (Qureshi, 1993). This may be an important factor for the plant to cease flowering by the mid-April and supply the available resources to the growing fruits to realize maximum fruit set.

A. rotundifolia with anthesis during morning hours and odourless flowers indicates that it is adapted for pollination during daytime. The floral characteristics of this plant, such as short-tubed corolla with anthers at the flower entrance, the styles and stigmas situated slightly

below the anthers, production of slightly moderate volume of nectar with high sugar concentration and presence of only hexose sugars in nectar, are adaptations for bee-pollination (Baker and Baker, 1983; Opler, 1983). Further, the nectar has the essential amino acids such as arginine, lysine, phenylalanine, threonine, tryptophan, valine and histidine, and also some non-essential amino acids. De Groot (1953) showed that insects in general and honeybees in particular require ten essential amino acids, and seven of them are present in the nectar of this plant. The pollen also has some protein content. The flower visitors recorded are exclusively honeybees and stingless bees; the latter are also honey producers. These bees collect both pollen and nectar from the flowers. They carry pollen on their bodies and pollinate the flowers while probing for the forage. As they require more quantity of forage for honey production and brood rearing, they collect forage from as many flowers as available on *A. rotundifolia* and hence, contribute to both self- and cross-pollination. Naskar and Mandal (1999) mentioned that this plant is pollinated by the honey bee, *Apis dorsata* in the Sundarban mangroves. Bhattacharya et al. (2006) also noted that the pollen of this plant is dominant in honey collected from the Sundarbans region. Therefore, *A. rotundifolia* is primarily melittophilous.

A. rotundifolia flowers are weakly protandrous, self-compatible and self-pollinating. The protandry does not contribute to autogamy in the first two hours of flower life as the stigmas lack receptivity during that period. Gradually, the stigmas diverge and stand away from the anthers while they attain receptivity to pollen. Individual flowers with this situation produce fruit through autogamy with the aid of wind or honeybees. The pollen grains are very large and fall down on the stigmas gravitationally due to wind action, the result of which is autogamy. If there are flowers of the same age, side by side in the same or adjacent inflorescences, geitonogamy may occur. However, the flower function with reference to protandry, movement of stigmas, and duration of stigma receptivity suggests that the plant is primarily evolved for outcrossing. Hand-pollination results also indicate the same and the fruit set rate is highest in open-pollinations, which are largely a function of foraging activity of bees. Despite high fruit set rate in this plant, its population size is small. Pollination among the individuals of this small population may lead to a reduction in genetic diversity and molecular studies on its genetic structure would enable to know the existing level of genetic variation. Transplanting the propagules from other mangrove forests, like mangrove of Mahanadi Delta of Orissa and the Sundarbans, to the study site would help to enhance gene flow in order to enable the plant to build up a stable and sustainable population size.

Seedling ecology. The flowers produce singled-ovuled ovary and the ovule invariably produces a single seed in fertilized flowers. This characteristic is advantageous for the plant to save and use the resources for higher fruit set rate. Seed is not dormant and produces hypocotyl within the fruit pericarp while still on the parent plant; it is a characteristic of crypto-viviparous species (Carey, 1934; Das and Ghose, 2003). The fruit with hypocotyl inside grows upward like the upwardly growing naked hypocotyl of *C. decandra*. Since the hypocotyl is concealed, the entire capsule-like fruit falls off when due for dispersal. Fruit pericarp is essential for the hypocotyl to float until it is settled. Self-planting and stranding strategies are functional for the dispersal of hypocotyls. But, field studies indicate that only a few of those hypocotyls which have fallen at the parental sites, settled well and showed further growth. Clarke and Kerrigan (2002) reported that the small-sized hypocotyls contain high nutrient content and low fiber content. The crabs prefer to consume such hypocotyls and feed on them prior to establishment. They also reported that 80% of the propagules failed to establish due to predation by crabs in *Aegialitis annulata*. Also, in the study site of *A. rotundifolia*, crabs are common and they may be consuming most of the hypocotyls prior to their establishment and hence, affecting the recruitment process of the plant.

CONCLUSIONS

The sexual system and breeding systems functional in *A. rotundifolia* facilitate to produce fruit with or without vectors. Further, the crypto-vivipary, self-planting and stranding strategies enable it to survive and build populations in the mangrove forest. The plant is a potential nectar and pollen source for visiting bees. Therefore, the interactions between the plant and bees benefit both, the former for pollination and the latter for forage.

ACKNOWLEDGEMENTS

We thank the Andhra University, Visakhapatnam, India, for providing facilities to carry out this research work.

REFERENCES

1. Aksornkoae S., Maxwell G., Havanond S. and Panichsuko S., 1992 – Plants in Mangroves, Chalongrat Co., Ltd., Thailand, 120.
2. Aziz T. N. A. and Hashim N. R., 2011 – Heavy metal concentrations in an important mangrove palm (*Nypa fruticans*), in Rembau-Linggi Mangrove Forest (Peninsular Malaysia); *Transylvanian Review of Systematical and Ecological Research*, 12, *The Wetlands Diversity*, 111-116.
3. Baker H. and Baker I., 1973 – Some anthecological aspects of evolution of nectar-producing flowers, particularly amino acid production in nectar, in *Taxonomy and Ecology*, Heywood (ed.), Academic Press, London, 243-264.
4. Baker H. G. and Baker I., 1983 – A brief historical review of the chemistry of floral nectar, in *The Biology of Nectaries*, Bentley B. and Elias T. (eds), Columbia University Press, New York, 126-152.
5. Bhattacharya K., Majumdar M. R. and Bhattacharya S. G., 2006 – A Textbook of Palynology (Basic and Applied), New Central Book Agency (P) Ltd., Kolkata, 352.
6. Carey G., 1934 – Further investigations on the embryology of viviparous seeds, *Proceedings of Linnean Society of New South Wales*, 59, 392-410.
7. Chapman V. J., 1976 – Mangrove vegetation, Cramer, Valduz, Germany, 447.
8. Clarke P. J. and Kerrigan R. A., 2002 – The effects of seed predators on the recruitment of mangroves, *The Journal of Ecology*, 90, 726-736.
9. Cruden R. W., 1977 – Pollen-ovule ratios: a conservative indicator of breeding systems in flowering plants, *Evolution*, 31, 32-46.
10. Dafni A., Kevan P. G. and Husband B. C., 2005 – Practical Pollination Biology, Enviroquest Ltd., Ontario, 590.
11. Das S. and Ghose M., 2003 – Seed structure and germination pattern of some Indian mangroves with taxonomic relevance, *Taiwania*, 48, 287-298.
12. De Groot A. P., 1953 – Protein and amino acid requirements of the honey bee (*Apis mellifera* L.), *Physiologia Comparata et Oecologia*, 3, 197-285.
13. Harborne J. B., 1973 – Phytochemical Methods, Chapman and Hall, London, 288.
14. Hogarth P. J. 1999 – The Biology of Mangroves, Oxford University Press, Oxford, England, ISBN 0-19-850222-2.
15. Kathiresan K. and Bingham B. L., 2001 – Biology of mangroves and mangrove ecosystems, *Advances in Marine Biology*, 40, 81-251.
16. Lowry O. H., Rosebrough N. J., Farr A. L. and Randall R. J., 1951 – Protein measurement with the folin phenol reagent, *The Journal of Biological Chemistry*, 193, 265-275.
17. Naskar K. and Mandal R., 1999 – Ecology and biodiversity of Indian Mangroves, Part I, Global Status, Daya Publishing House, New Delhi, 783.
18. Opler P. A., 1983 – Nectar production in a tropical ecosystem, in *The Biology of Nectaries*, Bentley B. and Elias T. (eds), Columbia University Press, Columbia, 30-79.
19. Qureshi M. T., 1993 – Rehabilitation and management of mangrove forests of Pakistan, in *Towards the Rational Use of High Salinity Tolerant Plants*, 1, Leith H. and Al Masoom A. (eds), Kluwer Academic Publishers, The Netherlands, 89-95.
20. Ramasubramanian R., Ravishankar T. and Sridhar D., 2003 – Mangroves of Andhra Pradesh. Identification and Conservation Manual, M. S. Swaminathan Research Foundation, Chennai, 48.
21. Scholander P. F., 1968 – How mangroves desalinate water, *Physiologia Plantarum*, 21, 251-261.
22. Tomlinson P. B., 1986 – The Botany of Mangroves, Cambridge University Press, New York, 413.

23. Weber-EI Ghobary M. O., 1984 – The systematic relationships of *Aegialitis* (Plumbaginaceae) as revealed by pollen morphology, *Plant Systematics and Evolution*, 144, 53-58.

MOLLUSC DIVERSITY AT PULICAT LAGOON (INDIA)

Ravichandran RAMANIBAI * and Sivalingam GOVINDAN **

* University of Madras, Department of Zoology, Guindy Campus, Sardar Patel Road, Chennai, Tamil Nadu, India, IN-600025, rramani8@hotmail.com, rramani8@unom.ac.in

** University of Madras, Department of Zoology, Guindy Campus, Sardar Patel Road, Chennai, Tamil Nadu, India, IN-600025, s.govindan88@gmail.com

DOI: 10.1515/trser-2018-0003

KEYWORDS: Diversity, bivalve, gastropod, ecosystem, Thiruvallur District, India.

ABSTRACT

During our routine ecological survey conducted at Pulicat Lagoon, the most diverse class Gastropods comprised of 26 families with 34 species and Bivalvia with 13 families and 17 species were recorded. The most abundant molluscs species was *Crassostrea madrasensis*, captured between October 2013 – September 2015. Quite a good number of molluscs were washed ashore. The economic value of the shells in the field of cosmetics was raised high recently. Both in terms of aquaculture and market value the attention should be diverted towards their conservation. With few exceptions, the majority of these molluscs were ornamental.

RÉSUMÉ: La diversité des mollusques du lagon de Pulicat (Inde).

Durant notre étude écologique de routine effectuée dans le lagon de Pulicat, la classe la plus diversifiée des Gastropodes contient 34 espèces et 26 familles suivies par les Bivalves avec 17 espèces et 13 familles. Dans les prises d'Octobre 2013 – Septembre 2015, l'espèce la plus abondante a été la *Crassostrea madrasensis*. Un grand nombre de mollusques s'échouent sur les rives et récemment. La valeur économique des coquillages a augmenté de manière significative. En ce qui concerne l'aquaculture ainsi que la valeur de marché, l'attention devrait se porter plus vers leur conservation. A quelques exceptions près, la grande majorité sont des mollusques ornementaux.

REZUMAT: Diversitatea moluștelor din Laguna Pulicat (India).

În cadrul studiului nostru ecologic de rutină, efectuat în laguna Pulicat, s-au înregistrat 34 specii din 26 familii aparținând clasei Gastropoda, cea mai bine reprezentată, și 17 specii din 13 familii aparținând clasei Bivalvia. În capturile din Octombrie 2013 – Septembrie 2015, specia cea mai abundentă a fost *Crassostrea madrasensis*. Un mare număr de moluște au fost aduse pe țărm de valuri. Valoarea economică a cochiliilor cu aplicații cosmetice a crescut recent. Atât în termeni de acvacultură cât și de valoare de piață, atenția trebuie reorientată către conservarea acestor specii. Cu câteva excepții, majoritatea acestor moluște sunt ornamentale.

INTRODUCTION

The role of molluscs proved to be beneficial both cost-effectively as well as medicinally in the recent past (Wosu, 2003). They are important to humans as a source of food, jewellery, tools and even pets. Molluscs play a significant role in public and veterinary health (Supian and Ikhwanuddin, 2002). *Biomphalaria glabratus* caused with schistosomiasis (Richards, 1970).

In India 3,271 molluscs belong to 220 families and 591 genera, of which 1,900 are gastropods, 1,100 are bivalves (Venkataraman and Venkataraman, 2012). The studies on Indian molluscs were initiated by the Asiatic Society of Bengal and the Indian museum, Calcutta (Venkataraman and Wafar, 2005). Subba Rao and Dey (2000) reported 3,370 species of marine molluscs in India, out of which 1,282 species were from Andaman and Nicobar Islands. Subba Rao (2003) contributed in the field of mollusc's faunal diversity from Indian coastal regions.

Pulicat Lake is one of the most productive ecosystems in India. Chacko et al. (1953) gave the first exhaustive account of the biodiversity of the Pulicat Lake and it has been considered as a classical benchmark in the field biodiversity of the Pulicat Lake (Sanjeeva Raj, 2003, 2006). In previous studies, we have reported the Avifaunal diversity at Pulicat Lagoon (Govindan et al., 2015). The distribution of the mollusc's fauna in the Pulicat Lagoon has been reported by Thangavelu and Sanjeeva Raj (1985). They have also described the extensive mining of molluscs shells (Thangavelu and Sanjeeva Raj, 1985) in the northern regions of the Pulicat Lagoon. In order to update already existing data on mollusc's diversity we conducted a two year survey, which covered the entire area of Pulicat Lagoon.

MATERIAL AND METHODS

Pulicat Lagoon is the second largest brackish water, lying partly in Tamil Nadu and Andhra Pradesh. In Tamil Nadu, the Pulicat Lagoon is located in Pulicat Village in Thiruvallur District. It is connected with the Bay of Bengal through a deep opening of about 0.8 km width situated about 1.6 km north of the Pulicat light house. Five sampling stations, namely Barmouth (S1), Kunankuppam (S2), Light house kuppam (S3), Sattankuppam (S4) and Jameelabad (S5) (Fig. 1) were selected at Pulicat Lagoon.

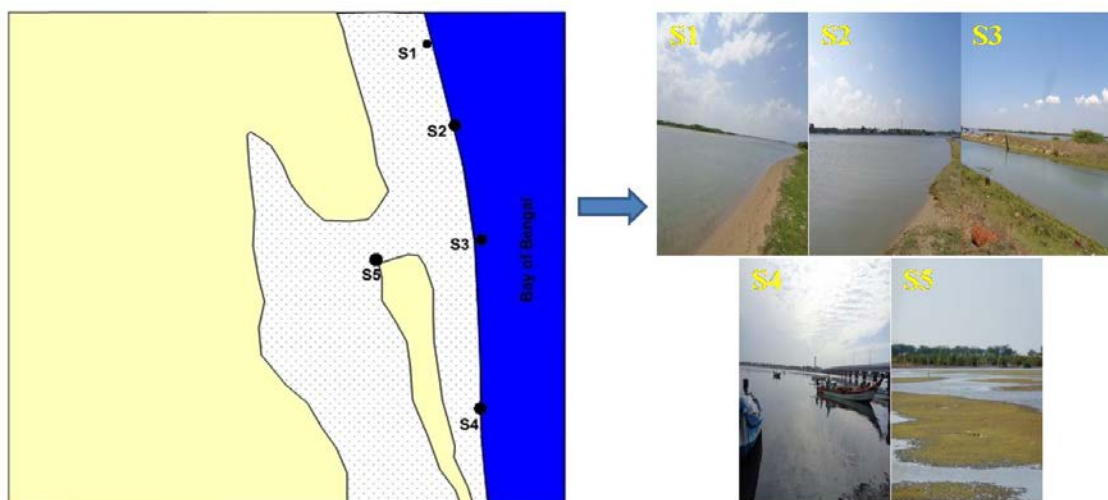

Figure 1: Sampling locations in Pulicat Lagoon.

The mollusc's shells were collected by hand picking, scraping method and through laboratory. The shells were washed with water to remove adhering debris without damaging and then dried. The collected molluscs were identified with morphological characters. The gastropods were mainly identified based on the spire length and shape, mouth opening, opercular, umbilicus, colour and ornamentation and bivalves on the hinge, interlocking dentition, with referred to elsewhere Richards (1970), Vannucci (2002), Subba Rao (2003), Ramakrishna and Dey (2010), Venkatraman and Venkatraman (2012).

The specific shell characters like spire shape and length, opercular, umbilicus, mouth cavity, colour and ornamentation, were used primarily for the recognition of studied gastropods. The studied bivalves were recognized principally based on the shell morphology and the two valves. The external surface may be striated and the two valves held together by a ligament and a scar on the hinge.

1. The Shannon-Wiener diversity index, Simpson's index and Margalef's richness index were calculated for estimating mollusc's diversity. The data were subjected to diversity indices and cluster analysis using PAST Software, Margalef index (Margalef, 1958).

Margalef's index was used as a simple measure of species richness

Margalef's index = $(S - 1)/\ln N$

S = total number of species

N = total number of individuals in the sample

ln = natural logarithm (Margalef, 1958)

2. Shannon Diversity Index "H"

$H = -\sum [(n_i/N) \times (\ln n_i/N)]$

H: Shannon Diversity Index

n_i: Individuals number associated to i species

N: Individuals total number (Magurran, 2004)

3. Simpson Diversity Index "D"

Simpson's index of dominance:

$D = \sum n_i (n_i - 1) / N (N - 1)$

Where, n_i = the total number of individuals of a particular species.

N = the total number of individuals of all species (Magurran, 2003)

4. Pielou Evenness Index "J" (Pielou, 1966)

$J = H/H_{max}$ J: Pielou evenness index H

The observed value of Shannon Shannon index H_{max}: lnS

S: Total number of species (Pielou, 1966)

RESULTS AND DISCUSSION

Gastropods and bivalves are the two major classes of phylum mollusc contributed by 39 families belonging to 51 species. The most diverse class: Gastropod has 26 families belonging to 29 genera, 34 species (Fig. 2; Tab. 1) and Bivalve included 13 families, 15 genera and 17 species (Fig. 3; Tab. 2). 39 family, 51 species were located at Barmouth (S1), 39 family, 50 species were located at Kunankuppam (S2), 29 family 35 species were located at Light house kuppam (S3), 27 family 23 species were located at Sattankuppam (S4) and at Jameelabad (S5) 25 family, 30 species were located (Tab. 1). The Conidae were found to be the dominant family in Pulicat Lagoon.

Gastropods and bivalves are generally benthic organisms and they are frequently used as bio indicators of aquatic health. A similar study was conducted at a few localities from the Raigad District the Maharashtra West Coast of India. Nearby 22% bivalves and 78% gastropods were recorded throughout October 2010 to September 2011 (Khade and Mane, 2012). In total 55 species of molluscs representing 13 orders, 30 families and 39 genera were recorded from the mangroves of Uran, Maharashtra (Pawar, 2012). An analogous study was carried out at Dadar and Juhu beach in Mumbai that revealed the availability of 19 genera and 14 families collectively on both coast lines. Most number of Bivalves belonged to the Cardidae while maximum Gastropods were from Trochidae family (Joshi et al., 2013). The study revealed that there is a good diversity of molluscs.



Figure 2: Distribution of Gastropods in Pulicat Lagoon.

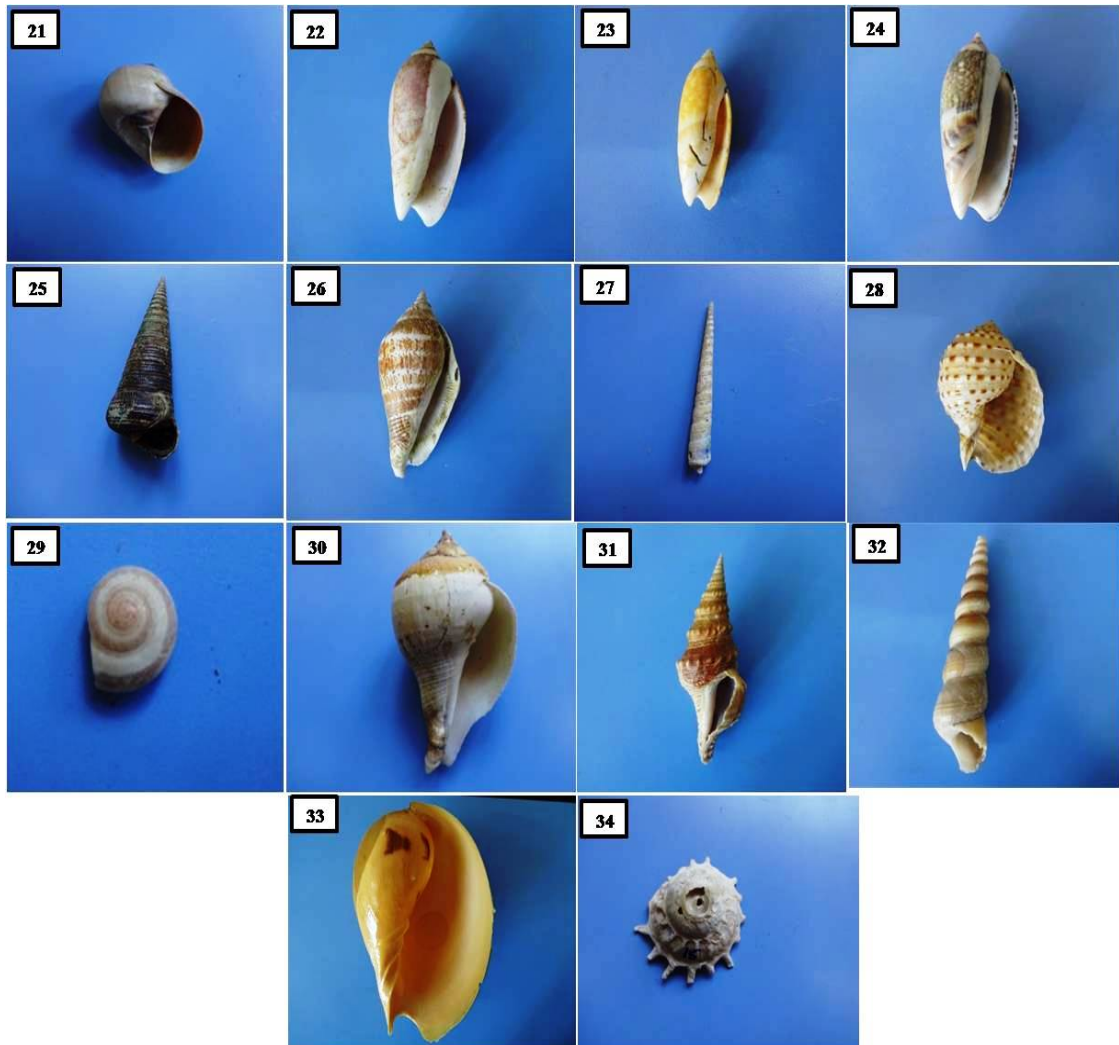

Figure 3: Distribution of Gastropods in Pulicat Lagoon.

Table 1: List of gastropod identified from Pulicat Lagoon.

Family	Name of the species	S1	S2	S3	S4	S5
1. Architectonicidae	<i>Architectonica perspectiva</i>	+	+	+	-	-
2. Babyloniidae	<i>Babylonia zeylanica</i>	+	+	+	-	-
3. Buccinidae	<i>Cantharus tranquebaricus</i>	+	+	+	-	+
4. Bullidae	<i>Bulla ampulla</i>	+	+	-	-	-
5. Bursidae	<i>Bufonaria echinata</i>	+	+	-	-	-
6. Cassidae	<i>Phalium glaucum</i>	+	+	+	+	+
7. Cerithiidae	<i>Rhinoclavis sordidula</i>	+	+	+	+	+
8. Chilodontidae	<i>Euchelus asper</i>	+	+	+	+	+
9. Conidae	<i>Conus amadis</i>	+	+	-	-	-
	<i>Conus betulinus</i>	+	+	+	+	+
	<i>Conus lentiginosus</i>	+	+	+	+	+
	<i>Conus virgo</i>	+	+	-	-	-
10. Fascioliidae	<i>Fusinus colus</i>	+	+	+	+	+
11. Ficidae	<i>Ficus variegata</i>	+	+	+	+	-
12. Harpidae	<i>Harpa major</i>	+	+	+	+	+
13. Melongenidae	<i>Pugilina conchlidium</i>	+	+	+	+	+
14. Muricidae	<i>Chicoreus virgineus</i>	+	+	+	-	-
	<i>Murex carbonnieri</i>	+	+	+	-	+
15. Naticidae	<i>Eunaticina papilla</i>	+	+	+	-	-
	<i>Natica lineata</i>	+	+	-	-	-
	<i>Natica vitellus</i>	+	+	+	+	+
16. Olividae	<i>Agaronia nebulosa</i>	+	+	-	-	-
	<i>Oliva caerulea</i>	+	+	+	+	+
	<i>Oliva oliva</i>	+	-	-	-	+
17. Potamididae	<i>Telescopium telescopium</i>	+	+	+	+	+
18. Strombidae	<i>Strombus marginatus succinctus</i>	+	+	+	+	+
19. Terebridae	<i>Hastula inconstans</i>	+	+	+	+	+
20. Tonnidae	<i>Tonna cumingi</i>	+	+	+	-	-
21. Trochidae	<i>Umboonium vestiarium</i>	+	+	-	-	-
22. Turbinellidae	<i>Turbinella pyrum</i>	+	+	-	-	+
23. Turridae	<i>Gemmula unedo</i>	+	+	+	+	+
24. Turritellidae	<i>Turritella attenuata</i>	+	+	-	-	-
25. Volutidae	<i>Melo melo</i>	+	+	+	+	+
26. Xenophoridae	<i>Xenophora solariformis</i>	+	+	-	-	-

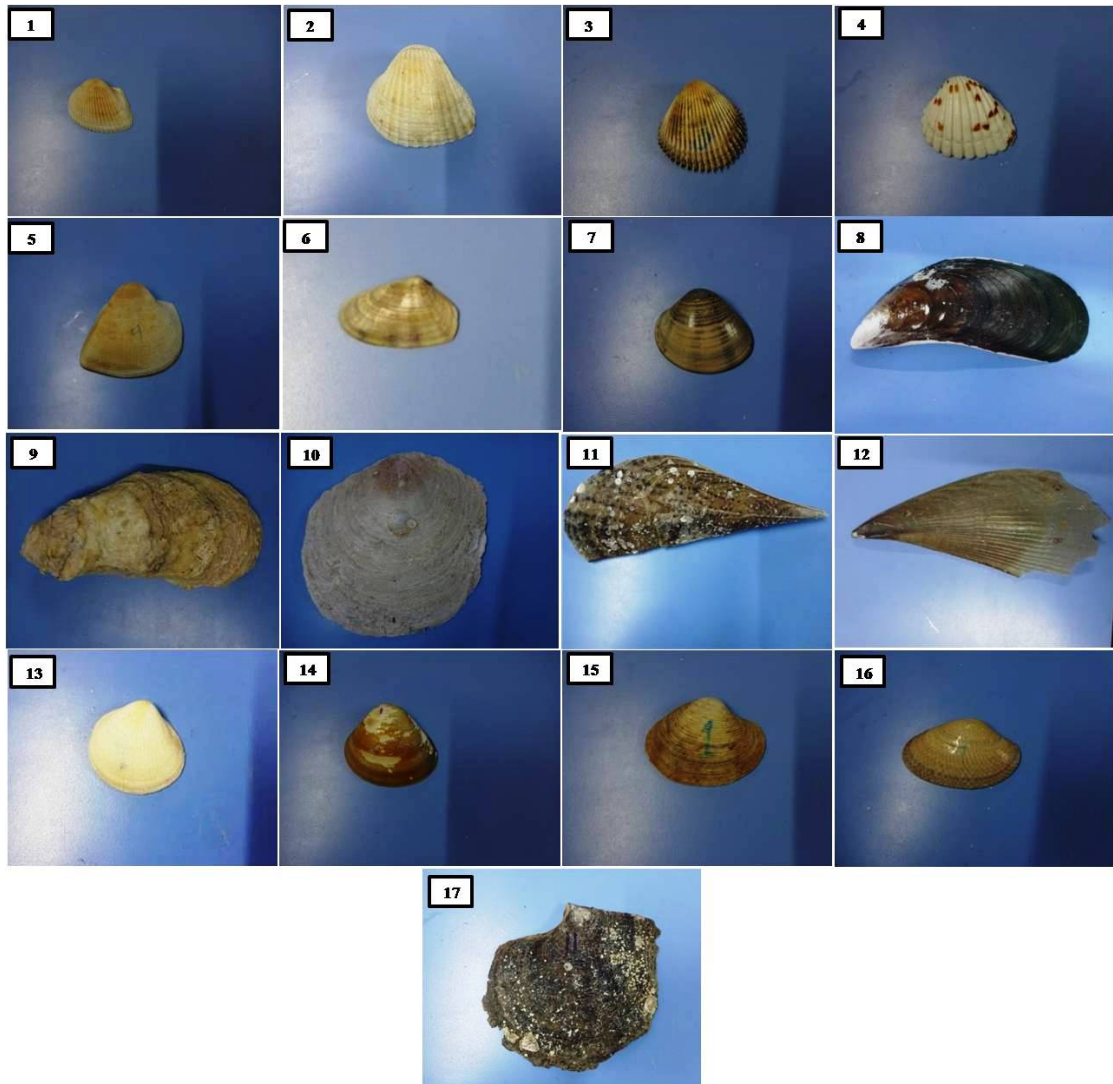

Figure 4: Distribution of Biavalve in Pulicat Lagoon.

Table 2: List of gastropod identified from Pulicat Lagoon.

Family	Name of the species	S1	S2	S3	S4	S5
Arcidae	<i>Anadara antiquate</i>	+	+	+	+	+
	<i>Anadara granosa</i>	+	+	+	+	+
Cardiidae	<i>Vasticardium flavum flavum</i>	+	+	-	-	-
Carditidae	<i>Cardita antiquata</i>	+	+	+	-	+
Cucullaeidae	<i>Cucullaea labiata</i>	+	+	+	+	-
Donacidae	<i>Donax cuneatus</i>	+	+	+	+	+
Mactridae	<i>Mactra antiquata</i>	+	+	+	+	+
Mytilidae	<i>Perna viridis</i>	+	+	-	-	-
Ostreidae	<i>Crassostrea madrasensis</i>	+	+	+	+	+
Placunidae	<i>Placuna placenta</i>	+	+	-	-	-
Pinnidae	<i>Atrina (Atrina) vexillum</i>	+	+	+	+	+
	<i>Pinna bicolor</i>	+	+	-	-	-
Tellinidae	<i>Tellina cancellata</i>	+	+	+	+	+
Veneridae	<i>Gafrarium tumidum</i>	+	+	+	+	+
	<i>Paphia malabarica</i>	+	+	+	+	+
	<i>Paphia textile</i>	+	+	+	+	+
Pteriidae	<i>Pinctada margaritifera</i>	+	+	-	-	-

Margalef index was minimum 1.329 during post monsoon 2014 at the Jameelabad (S5) and maximum 8.834 at monsoon 2014 were recorded in the Barmouth (S1) (Tab. 3). Margalef Diversity Index “Ma” has no limit value and it showed variation depending upon the number of species. Thus, it is used for comparison between the sites (Hazarika, 2013). The noticed value was 7.78 which was also at the inferior limit of the scale. Simson index was minimum 1.952 at the Jameelabad station (S5) in the time of post monsoon 2014 and maximum 27.118 at the Barmouth (S1) during the post monsoon 2015 was noticed (Tab. 3). Simpson index was closer to one pointed out almost acceptable diversity status of the Pulicat Lagoon. Shanon Wienerindex was minimum 1.040 in Jameelabad (S5) in the time of post monsoon 2014 and maximum 3.459 at Barmouth (S1) during the summer 2014 (Tab. 3). Diversity indices of mollusc’s communities showed that Shannon index value (H) was 0.50, which was not at all satisfactory as “H” value above three indicating better balance and stable habitat condition (Mandaville, 2002). Pielou index “J” showed that molluscs species found minimum 0.580 at the Jameelabad (S5) during the post monsoon 2014 and maximum 0.971 during the monsoon 2014 at Sattankuppam (S4) (Tab. 3). Pielou index “J” showed that molluscs species reported area in the studied area almost evenly distributed because our calculated values were closer to one (Mandaville, 2002).

Table 3: Molluscs fauna diversity indices of seasonal variations in 2013-2015.

Study period	Seasons	Stations	Diversity Indices			
			Margalef's (M)	Simpson's (1/D)	Shannon wiener (H)	Pielous's index
2013	Monsoon	S1	8.834	23.297	3.406	0.875
		S2	6.930	20.280	3.245	0.920
		S3	4.013	7.538	2.436	0.879
		S4	2.216	5.769	1.841	0.946
		S5	1.747	3.396	1.536	0.790
2014	Post monsoon	S1	7.112	26.793	3.438	0.914
		S2	6.740	16.788	3.087	0.861
		S3	3.852	12.651	2.700	0.917
		S4	1.953	5.063	1.853	0.891
		S5	1.329	1.952	1.040	0.580
	Summer	S1	8.121	25.979	3.459	0.904
		S2	7.062	18.862	3.186	0.904
		S3	3.875	6.000	2.232	0.805
		S4	1.846	4.091	1.587	0.886
		S5	1.535	3.558	1.505	0.840
	Premonsoon	S1	7.494	23.693	3.379	0.910
		S2	5.868	13.674	2.906	0.882
		S3	3.267	6.050	2.155	0.867
		S4	2.164	5.333	1.787	0.918
		S5	1.765	3.322	1.447	0.808
	Monsoon	S1	6.795	26.049	3.409	0.924
		S2	6.792	18.978	3.204	0.894
S3		4.973	13.984	2.901	0.913	
S4		5.049	15.291	2.805	0.971	
S5		4.010	11.700	2.676	0.909	
2015	Post monsoon	S1	6.937	27.118	3.448	0.917
		S2	5.985	20.806	3.205	0.909
		S3	5.016	18.250	3.061	0.940
		S4	3.940	7.759	2.405	0.867
		S5	3.168	7.496	2.327	0.859
	Summer	S1	6.691	26.661	3.427	0.929
		S2	6.123	21.486	3.232	0.909
		S3	4.275	13.501	2.797	0.905
		S4	3.244	8.426	2.369	0.898
		S5	4.200	12.524	2.732	0.897
	Premonsoon	S1	7.112	26.032	3.432	0.918
		S2	5.932	18.441	3.142	0.907
		S3	4.809	13.898	2.858	0.911
S4		3.478	11.025	2.510	0.951	
S5		3.981	12.411	2.697	0.916	

CONCLUSIONS

The present investigation on molluscs species diversity associated with the lagoon ecosystems along Pulicat Lagoon, revealed the distribution of 34 gastropods and 17 bivalves, totalling to 51 molluscs species with one species of gastropod was dominant, namely *C. madrasensis*. It might, therefore, be useful and rewarding to further investigate the contributions of these macroinvertebrates towards nutrient processing and survey their role as biomonitors.

ACKNOWLEDGEMENTS

The authors are thankful to Department of Science and Technology for providing financial assistance (RR. F. No. NRDMS/SC/ST/23/016 G).

REFERENCES

1. Chacko P. I., Abraham J. G. and Andal R., 1953 – Report on survey of the Flora, Fauna and Fisheries of the Pulicat Lake, Madras state, India, 1951-1952, *Contribution from the Fresh Water Fisheries Biological Station*, Madras, 8, 21.
2. Govindan S., Ramanibai R. and Balakrishnan T., 2015 – Avifaunal diversity and status of Pulicat Lagoon in Tamil Nadu, *India ZOO's PRINT*, 30, 24-27.
3. Hazarika P., 2013 – Diversity indices of macro invertebrates in the Satajan Wetland of Lakhimpur District, Assam Lakh, *Annals of Biological Research*, 4, 8, 68-72.
4. Joshi S., Tambe P., Oak G. and Kurve P., 2013 – To study molluscan shells diversity of two fun beaches of Mumbai, Maharashtra, National Conference on Biodiversity: Status and Challenges in Conservation – FAVEO.
5. Khade S. N. and Mane U. H., 2012 – Diversity of Bivalve and Gastropod, Molluscs of some localities from Raigad District, Maharashtra, west coast of India, *Recent Research in Science and Technology*, 4, 10, 43-48.
6. Magurran A. E., 2003 – Measuring biological diversity, Blackwell, ISBN: 978-0-632-05633-0, 264.
7. Mandaville S. M. 2002 – Benthic macroinvertebrates in freshwaters, Taxa tolerance values, metrics, protocols, Project H-1, Soil and water conservation society of Metro Halifax, 18, 1-48.
8. Margalef R., 1958 – Information theory in ecology, *General Systems*, 3, 36-71.
9. Pawar P. R., 2012 – Molluscan diversity in mangrove ecosystem of Uran from Raigad Navi Mumbai, Maharashtra, West Coast of India, *Bulletin of Environment, Pharmacology and Life Sciences*, 1, 6, 55-59.
10. Pielou E. C., 1966 – The measurement of diversity in different types of biological collections, *Journal of Theoretical Biology*, 13, 131-144.
11. Richards C. S., 1970 – Genetics of a Molluscan Vector of Schistosomiasis, *Nature*, 227, 806-810.
12. Ramakrishna and Dey A., 2010 – Annotated Checklist of Indian Marine Molluscs (Cephalopoda, Bivalvia and Scaphopoda), Part-I, *Records of the Zoological Survey of India, Occasional Paper*, 320, 1-357.
13. Sanjeeva Raj P. J., 2003 – Strategies for conserving the macro fauna of Pulicat Lake – A case study. Natural Aquatic Ecosystems of India, Thematic Biodiversity Strategy and Action Plan, The National Biodiversity Action Plan, India, 228-238.
14. Sanjeeva Raj P. J., 2006 – Macro fauna of Pulicat Lake, NBA Bulletin, 6, National Biodiversity Authority, Chennai, Tamil Nadu, India, 67.
15. Subba Rao N. V., 2003 – Indian Seashells, I, Polyplacophora and Gastropoda, Edit. Director, *Zoological Survey of India*, 1-426.
16. Subba Rao N. V., 2003 – Indian Seashells, I, Polyplacophora and Gastropoda, Edit. Director, *Zoological Survey of India*, India, 1-426.
17. Supian Z. and Ikhwanuddin A. M., 2002 – Population dynamics of freshwater molluscs (Gastropod: Melanoidestuberculata), in Crocker Range Park, Sabah, ASEAN, *Review of biodiversity and environmental conservation*, ARBEC, 1-9.
18. Thangavelu R. and Sanjeeva Raj P. J., 1985 – Exploitation of shell-deposits in Pulicat Lake, *Journal of the marine biological Association of India*, 27 (1 and 2), 124-128.
19. Vannucci M., 2002 – Indo-west Pacific mangroves, in Lacerda L. D. (ed.), *Mangrove ecosystems*, Springer, Berlin, 122-215.
20. Venkataraman K. M. and Wafar M. V. M., 2005 – Coastal and marine biodiversity of India, *Indian Journal of Marine Science*, 34, 1, 57-75
21. Venkataraman C. and Venkataraman K., 2012 – Diversity of Molluscan Fauna along the Chennai Coast, May 22nd International day for Biological Diversity Marine Biodiversity, 29-35.
22. Wosu L. O., 2003 – Commercial snail farming in West-Africa – A guide, ApExpress Publishers, NSukka-Nigeria.

ANTIOXIDANT SYSTEM OF RAPANS UNDER THE ACTION OF COPPER IONS AND ANIONIC DETERGENT

Oksana ERSHOVA *, Valentin TOPTIKOV *,
Tatyana LAVRENYUK *, Oleg KOVTUN * and Vladlen TOTSKY *

* Odessa National Mechnikov University, Dvoryanskaya Street 2, Odessa Ukraine, UA-65082, ershova@mail.ru, v.a.toptikov@gmail.com, v.totsky@onu.edu.ua

DOI: 10.1515/trser-2018-0004

KEYWORDS: *Rapana venosa*, antioxidant system, copper, anionic detergent.

ABSTRACT

The antioxidant system in various organs of rapana (*Rapana venosa*) has been studied in condition of contamination of medium with copper ions (5 and 10 MPC) and sodium dodecyl sulphate (5 and 20 MPC). The most significant changes in the antioxidant status of cells occurred mainly during the first hours (three-24 hours) of exposure to toxic compounds. At the end of observations (72 hours) stabilization of the main parameters of the antioxidant system and return of its main indicators to control values were noted. Ktenidiy proved to be the most sensitive organ reacting to toxic doses of both copper and sodium dodecyl sulphate in the medium. Nephridiy cells turned out to be weakly susceptible to the action of the studied toxicants. The high lability and power of the antioxidant system of rapans provides a significant adaptive potential for the mollusk.

RÉSUMÉ: Le système antioxydant des rapana veinés sous l'action des ions de cuivre et des détergents anioniques.

Le système antioxydant des différents organes des rapana veinés (*Rapana venosa*) a été étudié dans des conditions de contamination du milieu avec des ions de cuivre (5 et 10 MPC) et avec du lauryl sulphate de sodium (5 et 20 MPC). Les changements les plus importants dans le statut antioxydant des cellules a eu lieu durant les premières heures (trois-24 heures) d'exposition aux contaminants. A la fin des observations (72 heures) a été notée la stabilisation des principaux paramètres du système antioxydant et le retour des principaux indicateurs aux valeurs de contrôle. Les ctenidies ont été les organes les plus sensibles réagissant autant au cuivre qu'au lauryl sulphate de sodium dans le milieu. Les cellules des néphridies ont été peu sensible face à l'action des toxiques étudiés. L'étude a conclu sur l'efficacité du système antioxydant des rapana veinés, prouvant un potentiel adaptatif significatif de ce mollusque.

REZUMAT: Sistemul antioxidativ la Rapana sub acțiunea ionilor de cupru și a detergentilor anionici.

Sistemul antioxidativ al diferitelor organe ale rapanei (*Rapana venosa*) a fost studiat în condiții de contaminare a mediului cu ioni de cupru (5 și 10 MPC) și sodiu dodecil sulfat (5 și 20 MPC). Cele mai semnificative modificări în starea antioxidativă a celulelor au avut loc în special, în timpul primelor ore (trei-24 ore) de expunere la compușii toxici. La finalul perioadei de observație (72 ore) s-au notat stabilizarea principalilor parametri ai sistemului antioxidant și revenirea principalilor indicatori la valorile de control. Cele mai sensibile organe s-au dovedit a fi ctenidiile, care au reacționat atât la cupru cât și la sodiu dodecil sulfat la concentrații toxice în mediu. Celulele nefridiilor s-au dovedit a fi destul de slab susceptibile la acțiunea toxicelor studiate. Sistemul antioxidant al rapanei este foarte flexibil, ceea ce dovedește un potențial adaptativ semnificativ al acestei moluște.

INTRODUCTION

In recent decades, chemical pollution of the world's oceans has turned into a powerful and constantly acting factor on the marine biota (Sindermann, 1996; Khoshnood, 2017). Along with such widespread and well-studied pollutants as heavy metals; detergents (cleaning agents) are constantly being introduced to the coastal zone of the sea, and constantly present in insufficiently purified domestic sewage (Tyurin, 1994; Grousset et al., 1995; Smirnova et al., 2008). Both can have a negative impact on water quality, self-cleaning ability of water bodies, the human body, as well as potentiate effect of other pollutants (Khristoforova, 1989; Braginsky, 2003). Polluting agents lead not only to environmental deterioration, but also to the reduction of biological diversity (Khristoforova, 1989; Golovina, 2008).

It is known that hydrobionts need heavy metals as microelements for normal physiological activity (Avtsyn, 1987; Saenko, 1993). However, many metals are not transformed and, getting into the body of hydrobionts in excess, are accumulated in it. As a result, in the body of marine inhabitants there is a disruption of cellular metabolism, structure and permeability of cell membranes, increased peroxide oxidation of lipids and inhibition of oxidative phosphorylation (Golovina, 2008). Copper ranks second in toxicity after mercury, of the ten elements (Pb, Cu, Hg, Cd, As, Te, Zn, Sn, Mn, Ni), survival effect of which were tested in mussel and oyster embryos (Tamoznya and Goromosova, 1985). Excess concentration of copper ions in sea water has a significant effect on the physiological and biochemical status of fish and marine invertebrates, it inhibits growth of larvae of the Pacific mussel *Mytilus trossulus* (Yaroslavtseva and Sergeeva, 2005; Golovina, 2008). Ecological hazard of detergents is significantly less studied than that of pesticides, heavy metals and other toxicants. There are data that detergents led to inhibition of the filtration activity of freshwater mollusks, mussels and oysters, changed behaviour of the medicinal leech, suppressed activity of some enzymes in the gills of fish (Ostroumov et al., 1997). Surfactants in concentration of 0.50 – 0.25 mg/l cause death of crustaceans and fish, their lower concentrations inhibit growth and development of hydrobionts, impair absorption of food, inhibit chemoreceptor function, sublethal concentrations of detergents disrupt mobility of sex cells and sporulation in algae (Miseiko et al., 2001). When detergent concentrations reach one mg/l, plankton perish, at three mg/l daphnia perish, at 15 mg/l fish perish (Bogolyubova, 1997).

It is known that the antioxidant system is the first to react to environmental changes. Previously, we studied antioxidant system activity of gastropod *Rapana venosa* from various areas of the Black Sea with different contamination levels (Totsky et al., 2013). However, we did not study specific effects of individual pollutants on the shellfish organism. That said, the purpose of this study was to observe the reaction of antioxidant system of rapana to copper and anionic detergent in concentrations exceeding the limit.

MATERIAL AND METHODS

In the research we used sexually mature individuals of rapanas collected in the coastal water area of the Odessa Gulf in the summer of 2015. Mollusks were acclimatized to laboratory conditions for a week in several aerated aquariums with sea water taken from the area where the animals were caught. Each 200-liter aquarium contained 20-22 animals. The water in the aquariums was changed every second days.

After acclimation of the experimental group, the test compound was added to the water. When choosing experimental concentrations of the test substances we relied on the data presented in the work of Zaitsev et al. (2006). We used the following doses of the compounds: 1) copper sulphate at the concentration of 5 MPC (25 µg/l in terms of the copper ion), 2) copper sulphate at a concentration of 10 MPC, 3) sodium dodecyl sulphate (anionic detergent of many cleaning agents) at the concentration of 5 MPC 500 µg/l, 4) sodium dodecyl sulphate at the concentration of 20 MPC. It is known that in aqueous media, copper cations, reacting with metabolic by-products of organisms, quickly shift into bound insoluble state (Dyatlov et al., 2012). In this regard, copper sulphate was repeatedly introduced into the medium up to the required MPC value on the second day of the experiment. In the control group, the mollusks were kept in ordinary seawater.

After three, 24 and 72 hours, six-eight individuals of each group (control and experimental) were selected for analysis. At the end of the experiment, the rapanas were stored in a freezer at – 18°C.

For biochemical analysis we used ktenidiy, hepatopancreas and nephridiy of the mollusk. Homogenates were prepared according to the generally accepted method (Prokhorova, 1982). To prepare homogenates we combined tissues of several individuals of both sexes in equal proportions. The total antioxidant activity (TAA) was determined in the obtained samples according to inhibition degree of ascorbate- and ferroinduced oxidation of tvine-85 up to MDA (Goryachkovsky, 1998), content of malonic dialdehyde (MDA) (Stalnaya and Garishvili, 1977) and reduced glutathione (GSH) (Goryachkovsky, 1998).

The obtained data were calculated per gram of wet weight of the tissue. In this study, the results obtained for experimental animals are presented on percentage base with reference to the corresponding control values. Control was taken as 100%. The diagrams show the arithmetic mean of the values and their standard error. Statistical processing of the results was carried out using the application Microsoft Office Excel. The reliability of differences in the tested parameters was determined using Student's t-test for conjugate populations.

RESULTS AND DISCUSSION

Addition of either copper ions or sodium dodecyl sulphate to the environment did not lead to a change in the general activity of mollusks during the period under investigation and did not have lethal effect. This suggests that the revealed antioxidant system changes will reflect the adaptation process of mollusks to unfavourable conditions.

The choice of organs for investigation is determined by their physiological functions. Ktenidiy, as an organ, is the first to face polluted environment, and its work induce how the organism will be provided with oxygen. The role of nephridiy is determined by its excretory function, and one of the important tasks of hepatopancreas is neutralization of toxic compounds that get inside and are formed in the process of metabolism (Chukhchin, 1970).

One of the end products of the lipid peroxidation destructive effects is MDA. The level of this compound reflects the state of dynamic equilibrium between oxidants and antioxidants and gives a general idea about the state of the body's antioxidant defence system. The effects of copper and anionic detergent on the content of MDA in different organs of rapana are shown in figures 1 and 2. In control samples the content of dialdehyde in ktenidiy, depending on the variant of the experiment, ranged from 16.7 ± 1.7 to 24.2 ± 1.3 nmol/g of tissue, in hepatopancreas – from 21.8 ± 2.6 to 31.9 ± 2.5 nmol/g tissue, in nephridiy – from 15.4 ± 2.9 to 33.7 ± 1.6 nmol/g tissue.

Copper ions at a concentration of 5 MPC in the medium did not have a significant effect on the content of dialdehyde in all the tested organs of rapana throughout the entire observation period. An increase in the copper dose up to 10 MPC led to an increase of lipid peroxidation in some organs. Moreover, an increase of dialdehyde concentration in hepatopancreas was observed in all periods of exposure compared to the control, whereas in ktenidiy it was observed only at the beginning (three and 24 hours) of rapanas' dwelling in water containing copper sulphate. On the third day, the amount of MDA in ktenidiy returned to the control level. It suggests that the observed temporary increase in the level of dialdehyde in ktenidiy is not associated with destructive processes in this organ, but with the reorganization of membranes necessary for adjustment of this organ to new conditions (Los, 2001; Ozernyuk, 2003). The tissues of nephridiy of rapana proved to be the most resistant to the effect of copper toxic doses: in individuals of the experimental group MDA content did not differ significantly from the control during the entire observation period and at different concentrations of Cu^{2+} (Fig. 1).

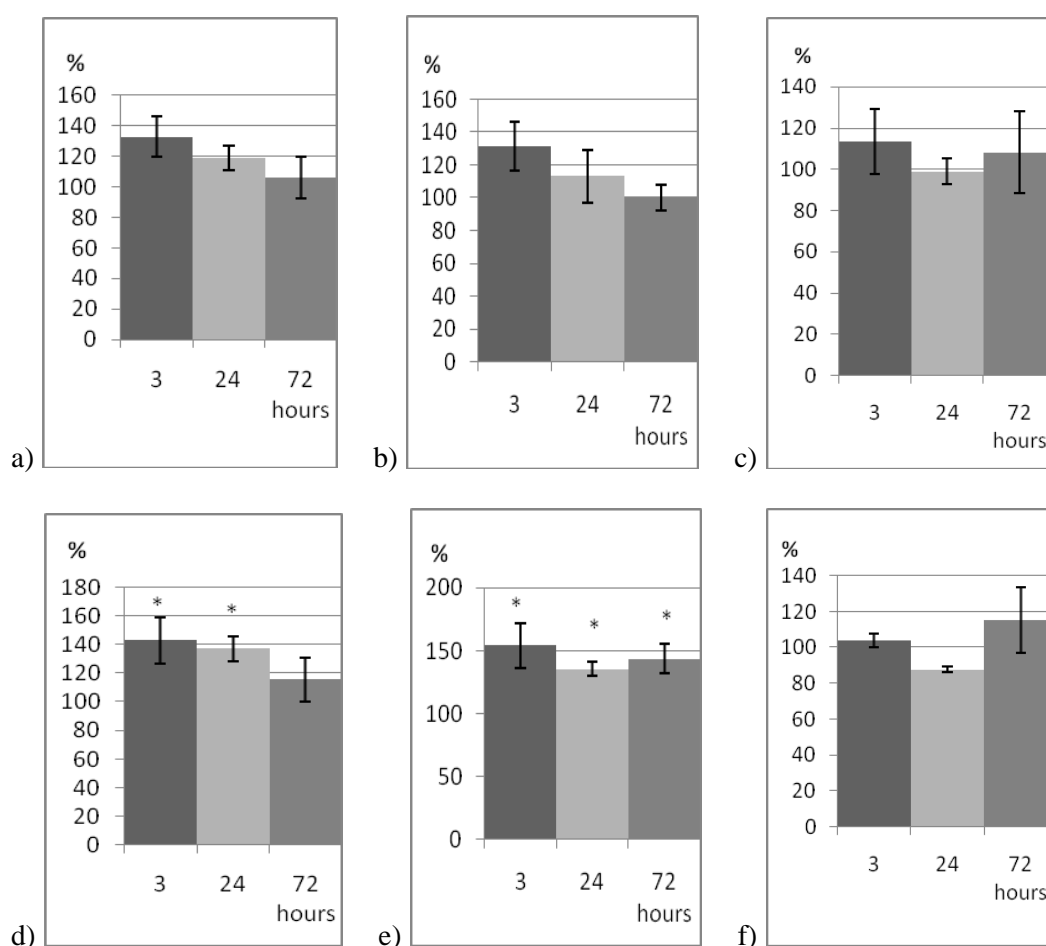

Figure 1: Dynamics of the content of MDA in ktenidiy (a, d), hepatopancreas (b, e) and nephridiy (c, f) rapana in the presence of copper ions;

a-c – 5 MPC Cu^{2+} , d-f – 10 MPC Cu^{2+} ;

* – significant difference from control at $P < 0.05$; the control values were taken as 100%.

Anionic detergent did not enhance lipid peroxidation in the cells of hepatopancreas and nephridiy of rapana (Fig. 2). More susceptible to the effect of this xenobiotic was ktenidiy. On the third day of exposure, the MDA level in the ktenidiy exceeded the control values by one and a half times which may indicate a significant damage to the detergent of the cell membranes of the ktenidiy (Fig. 2).

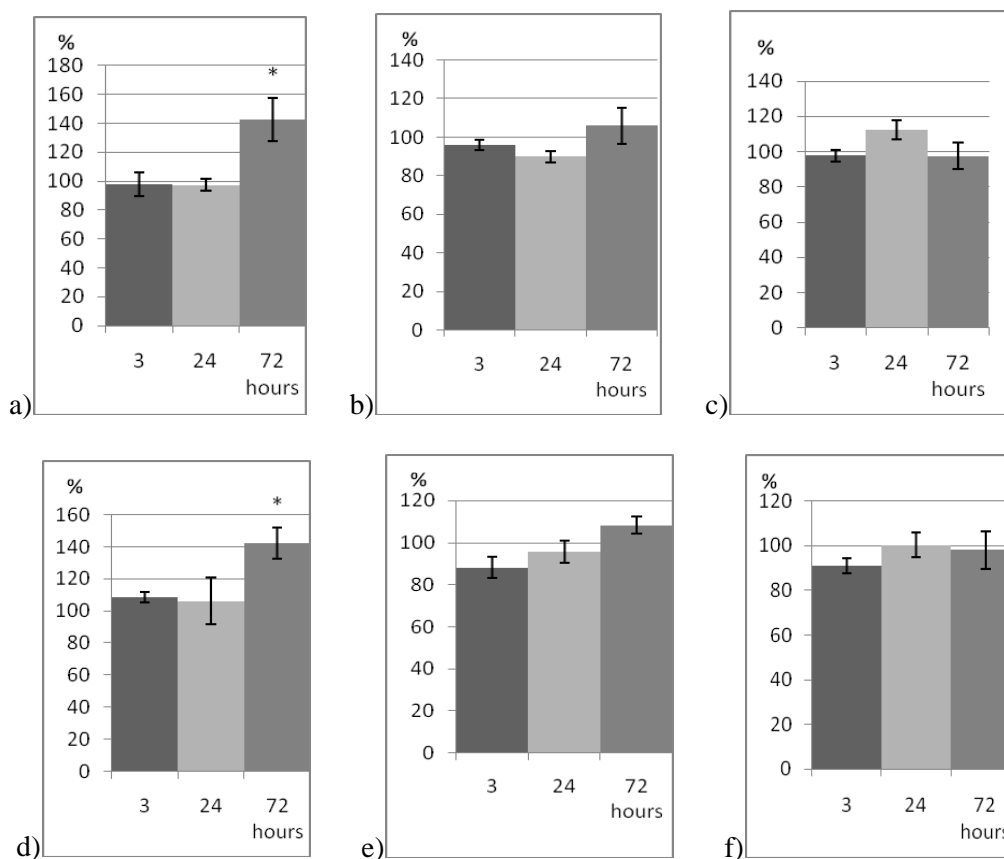

Figure 2: Dynamics of MDA content in ktenidiy (a, d), hepatopancreas (b, e) and nephridiy (c, f) rapans in the presence of sodium dodecyl sulphate; a-c – 5 MPC, d-f – 20 MPC; * – significant difference from control at $P < 0.05$; the control values were taken as 100%.

Glutathione reduced (GSH) is one of the most important non-enzymatic components of the antioxidant system. It exhibits both direct antioxidant activity and functions as a hydrogen donor for enzymes of the antioxidant system and supports the sulfhydryl groups of functionally important proteins in the reduced state (Kenya et al., 1993). In this regard, the definition of this component is important for assessing the state of the antioxidant system. The content of GSH, depending on the variants of the experiment in the ktenidiy control groups, was in the range 0.36 ± 0.03 to 0.62 ± 0.06 nmol/g tissue, in hepatopancreas from 0.40 ± 0.05 to 1.20 ± 0.35 nmol/g tissue, in nephridiy from 0.22 ± 0.03 to 0.36 ± 0.03 nmol/g tissue.

Determination of the level of GSH in the studied tissues of rapana showed that the most stable in this indicator were nephridiy cells. In the presence of toxic concentrations of copper, the amount of antioxidant in this organ did not differ from the control, and on the third day of the detergent's effect it even increased by one and a half times in comparison with the control values (Figs. 3 and 4).

The paradoxical response of the antioxidant system to toxicants was observed in the tissues of the ktenidiy and hepatopancreas (Fig. 3). Thus, a significant decrease in the amount of glutathione in the ktenidiy occurred only at a Cu^{2+} concentration in the mollusk habitat of 5 MPC. A higher dose of the toxicant did not have a significant effect. Similarly, in hepatopancreas at higher copper concentrations, the change occurred later and to a lesser extent: five times the maximum concentration of copper caused a decrease in the level of GSH by three times after three hours of exposure, 10 times the MPC twice a day. After the decrease in the amount of reduced glutathione observed in the tissues of the ktenidiy and hepatopancreas at the end of the exposure, there was no significant effect of copper. This may be due either to the activation of glutathione reductase restoring oxidized glutathione, or to the stimulation of the synthesis of this antioxidant due to other adaptation mechanisms.

The presence of sodium dodecyl sulphate in the medium did not significantly affect the content of reduced glutathione in hepatopancreas cells, whereas in the ktenidiy both concentrations of detergent caused a significant increase in the amount of GSH from the very beginning of the observations (Fig. 4).

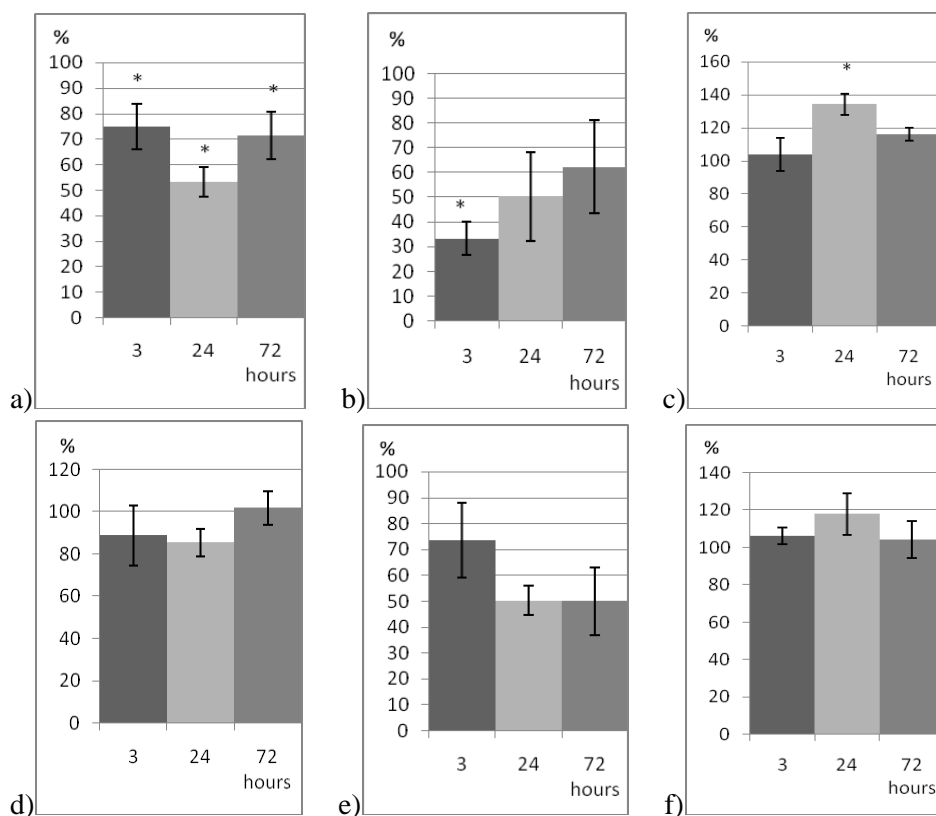

Figure 3: Dynamics of the content of reduced glutathione in ktenidiy (a, d), hepatopancreas (b, e) and nephridiy (c, f) in the presence of copper ions; a-c – 5 MPC Cu^{2+} , d-f – 10 MPC Cu^{2+} ; * – significant difference from control at $P < 0.05$; the control values were taken as 100%.

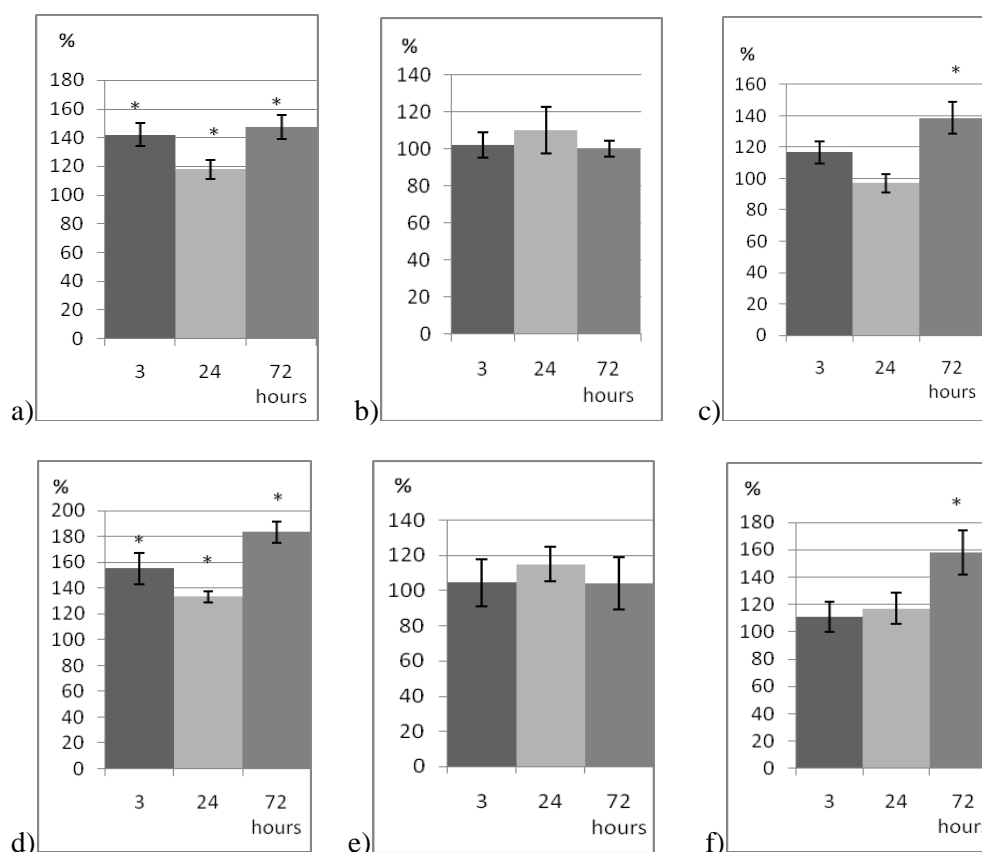

Figure 4: Dynamics of the content of reduced glutathione in ktenidiy (a, d), hepatopancreas (b, e) and nephridiy (c, f) rapans in the presence of sodium dodecyl sulphate; a-c – 5 MPC, d-f – 20 MPC; * – significant difference from control at $P < 0.05$; the control values were taken as 100%.

One more integral indicator was used to determine the state of the antioxidant system, which reflects the body's ability to counteract the development of free radical reactions – total antioxidant activity (TAA). The investigated doses of copper ions did not lead during the entire period of observations to significant changes in TAA in nephridiy and hepatopancreas of experimental mollusks in comparison with control ones. In ktenidiy there was a temporary weakening of the overall antiradical protection of cells by three hours of exposure at the maximum used concentration of this toxicant (10 MPC). But within a day the given indicator returned to the norm (Fig. 5d).

Similarly, the detergent also influenced the cells of the ktenidiy: after a decrease in the level of TAA to three hours of aging of the rapana in a medium with xenobiotic, after 24 hours its recovery to control values was noted (Figs. 6a, d). Unlike copper, sodium dodecyl sulphate exerted a marked effect on the state of the overall antioxidant activity in nephridiy and hepatopancreas, which manifested itself at the end of the aging of the rapana in a detergent medium (Figs. 6b, e, f).

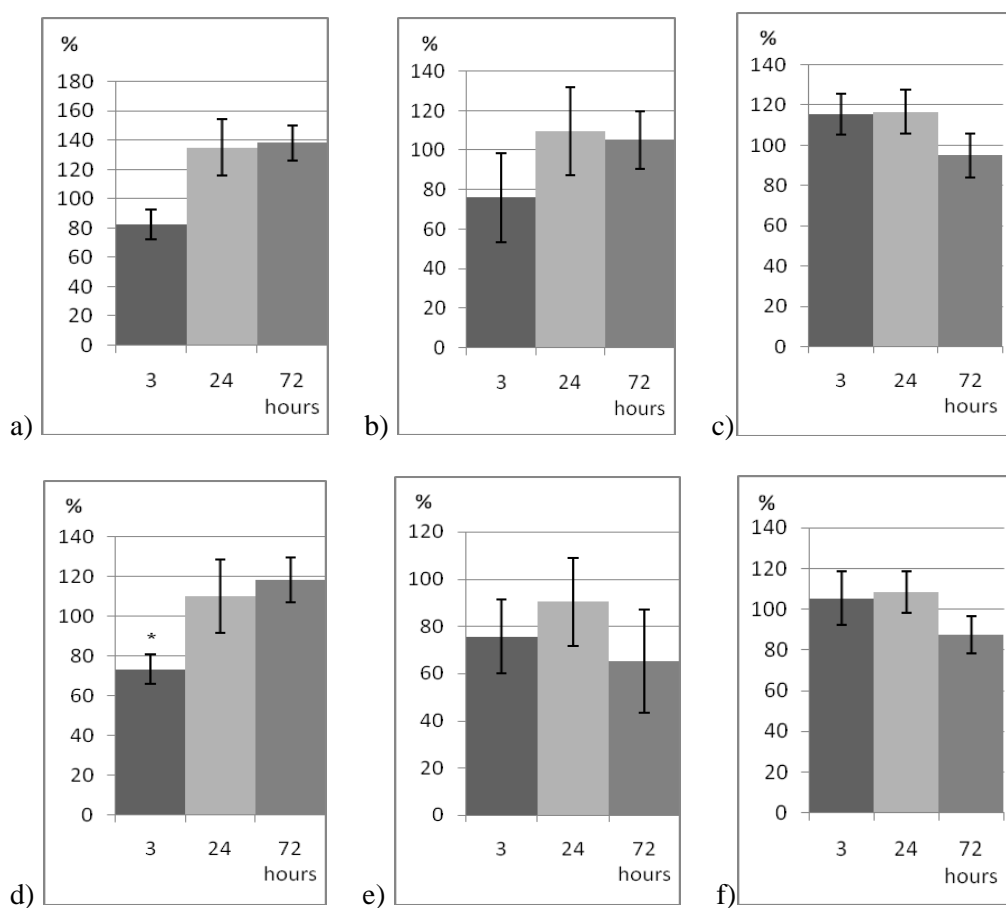

Figure 5: Dynamics of total antioxidant activity in ktenidiy (a, d), hepatopancreas (b, e) and nephridiy (c, f) in the presence of copper ions; a-c – 5 MPC Cu^{2+} , d-f – 10 MPC Cu^{2+} ; * – significant difference from control at $P < 0.05$; the control values were taken as 100%.

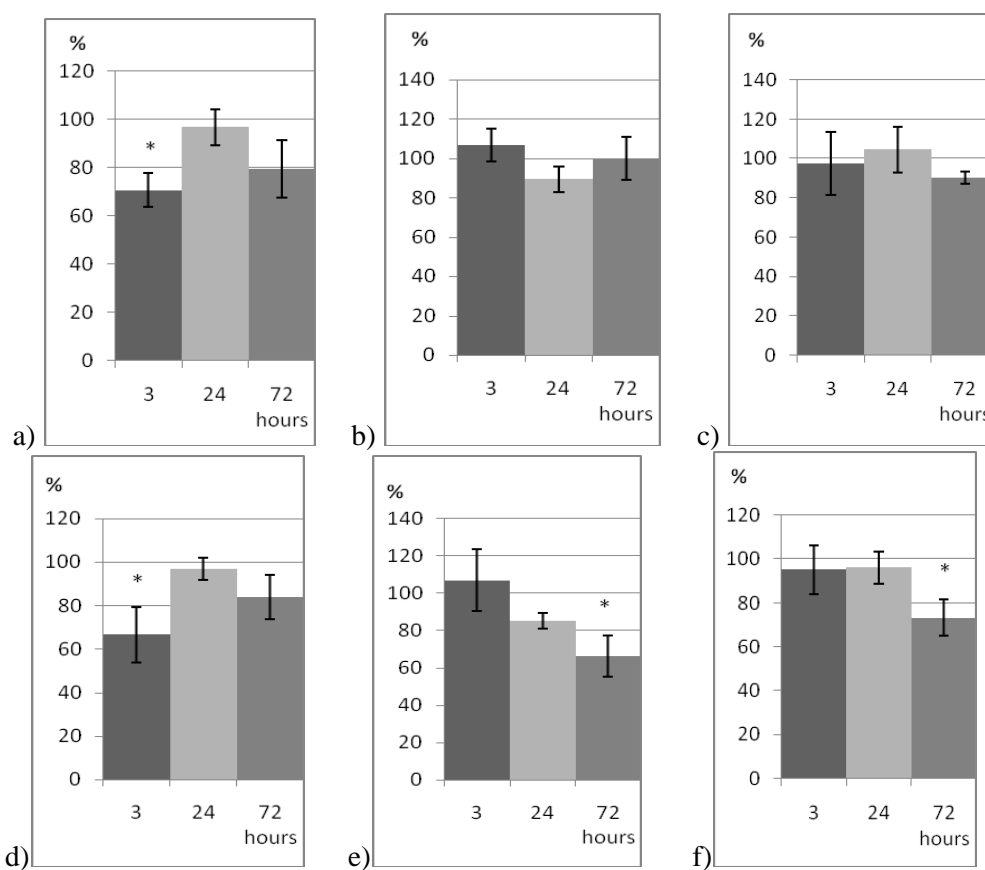

Figure 6: Dynamics of total antioxidant activity in ktenidiy (a, d), hepatopancreas (b, e) and nephridiy (c, f) rapans in the presence of sodium dodecyl sulphate; a-c – 5 MPC; d-f – 20 MPC; * – significant difference from control at $P < 0.05$; the control values were taken as 100%.

It is possible to make some assumptions about the possible mechanisms of the reaction of the antioxidant system of rapana in response to the effects of the toxicants under study comparing the direction of changes in the studied indicators. It is likely that the reduced glutathione plays a leading role in the formation of antioxidant protection of rapans, as changes in its concentration in cells are associated with changes in the level of TAA and the content of dialdehyde. Thus, a decrease in the total antioxidant activity in the ktenidiy in a medium with a detergent (Figs. 6a, d) and an increase in the amount of MDA in the ktenidiy by three hours of exposure (Figs. 2a, d) was accompanied by an increase in the concentration of glutathione in the tissues of the organ, followed by normalization of the general state of the antioxidant system (Figs. 4a, d). The drop in the level of TAA in nephridiy (Fig. 6f) in the presence of sodium dodecyl sulphate is associated with an increase in the content of GSH in its tissues (Fig. 4c). Also in the hepatopancreas of a mollusk on media with copper ions, an increase in the content of dialdehyde in the first hours of exposure (Fig. 1b) is associated with a subsequent increase in the concentration of glutathione in cells (Fig. 3b).

Diverse organs of the mollusc react to the environment pollution in a different way. Ktenidiy is the most sensitive organ that reacts to the presence of toxic doses in the environment, both copper and sodium dodecyl sulphate (Figs. 1d, 2a, d, 3a, 4a, d, 5d). This fact can be interpreted by the fact that the cells of this organ come first into contact with the habitat and its elements. The cells of nephridiy did not react to the presence in the medium of increased doses of copper, but were more sensible to the detergent (Figs. 4c, f, 6f). In hepatopancreas cells, the presence of copper in the environment led to enhanced lipid oxidation (Fig. 1e), which was neutralized by a relative increase in the level of reduced glutathione and stabilization of the level of total antioxidant activity (= antiradical ability).

CONCLUSIONS

Despite the pollution of the aquatic environment, the species *R. venosa* is rapidly advancing in various areas of the World Ocean. Successful settlement of this mollusk is associated with its high plasticity, undemanding to the physicochemical conditions of the environment and food sources, a number of general biological features, ontogenetic in particular.

As our studies show, the wide adaptive capabilities of rapana are also determined by the properties of its antioxidant system. It is shown that the reaction of the antioxidant system of rapans in response to unfavourable environmental conditions (high content of copper ions and anionic detergent) occurs already in the first hours of exposure. However, after 24 hours, the state of the antioxidant protection system of the mollusk is relatively stabilized and many of its indices return to normal. This indicates a significant capacity and lability of antioxidant mechanisms of rapans. The results obtained are additional evidence of numerous observations on the high ductility and adaptability of *R. venosa*.

ACKNOWLEDGEMENTS

The authors thanks to the head of department of water quality, Senior Researcher Institute of marine biology of NASU, Mr. Dyatlov for consultation in the planning of the experiment.

REFERENCES

1. Avtsyn A. P., 1987 – Human microelementoses, *Clinical medicine*, T. 65, 6, 36-44. (in Russian)
2. Bogolyubov S. A., 1997 – Ecology, Textbook, Knowledge, 288. (in Russian)
3. Braginsky L. P., 2003 – Comprehensive analysis of the toxicological hazard of surfactants for hydrobionts, *Hydrobiological Journal*, 39, 3, 115-118. (in Russian)
4. Chukhchin V. D., 1970 – Functional morphology of rapana, *Naukova Dumka*, 138. (in Russian)
5. Dyatlov S. E., Chepizhko O. V. and Urda V. A., 2012 – Interannual variability of heavy metals in water and sediments landfill "Odessa region NWBS" Ecological safety of coastal and shelf zones and complex use of shelf resources, 26, V.1., S. 257-268. (in Ukrainian)
6. Golovina I. L., 2008 – The influence of heavy metals on the physiological and biochemical status of fish and aquatic invertebrates, *Biology of inland waters*, 1, 99-108. (in Russian)
7. Goryachkovsky A. M., 1998 – Clinical Biochemistry, 2nd edition, Astroprint, 608. (in Ukrainian)
8. Grousset F. E., Quétel C. R. and Thomas B., 1995 – Anthropogenic vs. lithogenic origins of trace elements (As, Cd, Pb, Rb, Sb, Sn, Zn) in water column particles: Northwestern Mediterranean Sea, *Marine Chemistry*, 48, 3-4, 291-310.
9. Kenya M. V., Lukash A. I. and Guskov E. P., 1993 – The role of low-molecular antioxidants in oxidative stress, *Successes of the modern Biology*, 113, 4, 456-470. (in Russian)
10. Khoshnood Z., 2017 – Effects of environmental pollution on fish: a short review, *Transylvanian Review of Systematical and Ecological Research*, 19.1, *The Wetlands Diversity*, 49-60.
11. Khriforova N. K., 1989 – Bioindication and monitoring of pollution of sea water by heavy metals, Far East Branch of the Academy of Sciences of the USSR, *Science*, 192. (in Russian)
12. Los D. A., 2001 – Structure, regulation of experiment and functioning of desaturates of fatty acids, *Uspekhi biology, Chemistry*, 41, 163-198. (in Russian)
13. Miseiko G. N., Bezmaternykh D. M. and Tushkova G. I., 2001 – Biological analysis of the quality of fresh water, Barnaul AGU, 201. (in Russian)
14. Mitropolskiy A. Y., Nasedkina E. I. and Osokina N. P., 2006 – Ekoheohimiya Black Sea, *Academperiodica*, 278. (in Ukrainian)
15. Ostroumov S. A., Donkin P. and Staff F., 1997 – Inhibition by the anionic surfactant of the ability of *Mytilus edulis* mussels to filter and purify seawater, *Vestnik Moscow University*, 16, *Biology*, 2, 30-35. (in Russian)
16. Ozernyuk N. D., 2003 – Phenomenology and mechanisms of adaptation processes, Moscow, MSUU, 215. (in Russian)
17. Prokhorova M. I., 1982 – Methods of biochemical research (lipid and energy metabolism), Leningrad, Leningrad University, 271. (in Russian)
18. Saenko G. N., 1993 – Metals and halogens in marine organisms, *Science*, 252. (in Russian)
19. Sindermann C. J., 1996 – Ocean Pollution: Effects on Living resources and Humans, CRC Press, Boca Raton, FL, ISBN 0-8493-8421-4, 262.
20. Smirnova L. L., Andreeva N. A. and Saltykova L. V., 2008 – Microelement composition and microflora of the atmospheric suspension of the seaside of the city of Sevastopol (Black Sea), Urban ecology and recreational areas: Material All-Ukrainian scientific and practical conference April 17-18, Odessa, 208-211. (in Russian)
21. Stalnaya D. I. and Garishvili T. G., 1977 – Method for the determination of malonic dialdehyde with thiobarbituric acid/Cb. Modern methods in biochemistry, Moscow, 66-68. (in Russian)
22. Tamoznya V. A. and Goromosova S. A., 1985 – Biochemical indices of metabolism of mussels during the action of toxins on them, *Ecology of the Sea*, 16, 64-68. (in Russian)
23. Totsky V. N., Ershova O. N., Toptikov V. A., Kovtun O. A., Dragoeva A. G. and Lavrenyuk T. I., 2013 – The state of the antioxidant system in representatives of *Rapana venosa* (Valenciennes, 1846), inhabiting different waters of the Odessa Bay (Black Sea), *Vestnik ONU, Biologiya*, 18, 1, 30, 7-19. (in Russian)

24. Tyurin A. N., 1994 – Action of metal ions and detergents on the development of chitons, Author's abstract, Vladivostok. (in Russian)
25. Yaroslavtseva L. M. and Sergeeva E. P., 2005 – Influence of copper ions on the early stages of development of the Pacific mussel *Mytilus trossulus*, Institute of Marine Biology, Far East Branch, *Russian Academy of Sciences, Marine Biology*, 31, 4, 267-273. (in Russian)
26. Zaitsev Y. P., Aleksandrov B. G. and Minicheva G. G., 2006 – North-Western part of the Black Sea: biology and ecology, *Naukova Dumka*, 701s. (in Russian)

A REVIEW OF LENGTH-WEIGHT RELATIONSHIPS OF FRESHWATER FISHES IN MALAYSIA

Amonodin MOHAMAD RADHI *, Mohd-Fadzil NURUL FAZLINDA **,
Mohammad Noor Azmai AMAL *** and Hashim ROHASLINEY *

* Department of Environmental Management, Faculty of Environmental Studies, Universiti Putra Serdang, Selangor, Malaysia, MY-43400, radhi_aminuddin@yahoo.com, rohasliney@upm.edu.my

** School of Biological Sciences, Universiti Sains Malaysia, USM, Pulau Pinang, Malaysia, MY-11800, linda_fadzil91@yahoo.com

*** Department of Biology, Faculty of Science, Universiti Putra Malaysia, Serdang, Selangor, Malaysia, MY-43400, mnamal@upm.edu.my

DOI: 10.1515/trser-2018-0005

KEYWORDS: Freshwater fishes, Length-weight relationships, Malaysia.

ABSTRACT

This manuscript reviews the length-weight relationships (LWRs) of freshwater fishes in Malaysia. A total of 102 LWRs of fishes gathered from literature pertaining to 64 freshwater fish species were analysed. A meta-analysis from 13 previous reports showed that the b values was ranged from 2.19 (*Clarias batrachus*) to 4.106 (*Barbodes binotatus*). Out of 64 observed species, 47 species (11 families) experienced positive allometric growth, while another 23 species (eight families) and 31 species (12 families) were recorded under isometric and negative allometric growth, respectively. The fish LWRs observed can be used as an indicator of environmental changes and fish ecological health for freshwater fishes in Malaysia.

ZUSAMMENFASSUNG: Eine Überprüfung der Länge-Gewicht Beziehungen von Süßwasserfischen in Malaysia.

Vorliegende Arbeit befasst sich mit der Überprüfung der Längengewichtsverhältnisse (LWRs) von Süßwasserfischen in Malaysia. Insgesamt wurden 102 LWRs von 64 Süßwasserfischarten anhand von Literaturangaben analysiert. Eine Metaanalyse aus 13 früheren Berichten zeigte, dass die b -Werte von 2,19 (*Clarias batrachus*) bis 4.106 (*Barbodes binotatus*) reichen. Von 64 beobachteten Arten zeigten 47 Arten (elf Familien) ein positives allometrisches Wachstum, während weitere 23 Arten (acht Familien) und 31 Arten (12 Familien) unter isometrischem und negativem allometrischem Wachstum aufgezeichnet wurden. Die beobachteten Fische LWRs können als Indikatoren für Umweltveränderungen und Bewertung der ökologischen Gesundheit von Süßwasserfischen in Malaysia verwendet werden.

REZUMAT: O revizuire a relațiilor lungime-greutate a peștilor de apă dulce din Malaezia.

Această lucrare analizează dinamica în timp a relațiilor lungime-greutate (LWRs) la specii de pești de apă dulce din Malaezia. Au fost analizate un total de 102 LWRs selectate din literatura de specialitate, referitoare la 64 de specii de pești de apă dulce. O meta-analiză a datelor din 13 rapoarte anterioare a arătat că valorile b a variat între 2,19 (*Clarias batrachus*) și 4,106 (*Barbodes binotatus*). Din 64 de specii observate, 47 de specii (11 familii) au cunoscut o creștere alometrică pozitivă, în timp ce alte 23 de specii (opt familii) și 31 specii (12 familii) au fost înregistrate în creștere alometrică izometrice și negative, respectiv. LWRs observat a peștilor poate fi folosit ca un indicator al schimbărilor de mediu și de sănătate ecologică pentru pești de apă dulce din Malaezia.

INTRODUCTION

A total of 1,951 species of freshwater and marine fish belonging to 704 genera and 186 families have been recorded in Malaysia (Chonget al., 2010). In Peninsular Malaysia alone, about 278 native species were recorded by Lim and Tan (2002). The IUCN Red List of Threatened Species listed 1,275 fish species that are threatened from around the world and surprisingly, Malaysia hosts over 49 threatened fish species (Vié et al., 2008). At present, the indigenous species such as Jullien's golden carp (*Probarbus jullieni*), mahseer (*Tor tambroides*), Hoven's carp (*Leptobarbus hoeveni*), hampala barb (*Hampala macrolepidota*), climbing perch (*Anabas testudineus*), giant snakehead (*Channa micropeltes*), Asian arowana (*Scleropages formosus*), pangasiid catfishes (*Pangasius nasutus*, *Pangasigodon waandersii*), giant river catfish (*Wallago leerii*), catfish (*Clarias macrocephalus*) and giant gourami (*Osphronemus goramy*) have dwindled in great numbers continuously due to unsustainable fishing activities and could only be conserved probably in the inaccessible or remote areas of the country (Chew and Zulkafli, 2007). Moreover, freshwater ecosystems are demarcated due to the potential impacts of anthropogenic activities, giving them precedence for research, conservation, and sustainable management. Chong et al., (2010) reported that freshwater fishes recently encompassed the highest percentage of threatened fish species followed by estuarine among the aquatic systems. The diversity and distribution of freshwater fishes in Malaysia has been disrupted rapidly due to developmental pressure and modification of fish habitat. Future declines can therefore negatively affect freshwater biodiversity (Zakaria-Ismail, 1991; Bowen et al., 2003).

Length-weight analysis is a useful analysis in estimating average weight of fish caught from samples of lengths of fish caught (Hilborn and Walters, 2001; Adaka et al., 2015). The length-weight relationship (LWR) of fishes is important in fisheries and fish biology studies to provide information regarding growth patterns and the condition of fish species (Bagenal and Tesch, 1978). The study of LWRs is also important for the conservation and management of fishes in aquatic system, including freshwater system (Lawson, 2011), which are the most plausible area of efficacious pollutant sources due to the frequency, duration and magnitude of anthropogenic influences (Rahel, 2007; Francis, 2012).

Ricker (1975) has expressed the relationship between length (L) and weight (W) as $W = aL^b$. The constant value, a , has the ability to interpret body shape. For example, when the a value is 0.001, it shown that the fish is more eel-like, 0.008 more elongated, 0.013 more fusiform and 0.018 more short and deep (Froese, 2006). The value of b exponent depicts very important information of fish growth capability to predict the health of the fish. When b is equal to 3, the increase in weight is isometric which means the fish length and weight increases proportionally (Santos et al., 2002). If the value $b > 3$ (positive allometric), then there is a significant positive relationship between weight and fish length which indicates that weight will increase with increasing length, thus as the fish length increases the more rotund the fish will become; while when $b < 3$ (negative allometric), then the weight will decrease with increase of fish length, thus as fish length increase the less rotund the fish will become (Jones et al., 1999). Negative allometric growth pattern shows that there are possibilities of unsuitable environmental conditions which influence the condition to these species. Fish growth may be influenced by many biotic and abiotic factors such as phytoplankton abundance, predation, water temperature, and dissolve oxygen concentrations among others which may not favour the survival of all the species in the ecosystem (Atama et al., 2013).

Currently, researchers also use Bayesian length weight to compare between genera. Bayesian methods combine existing knowledge (prior probabilities) with additional knowledge derived from new data (the likelihood function) (Froese et al., 2014). This results in updated knowledge (posterior probabilities), which can be used as priors in subsequent analyses and thus provide learning chains in science (Kurikka et al., 2014). This method uses FishBase (www.fishbase.org) as an online tool that facilitates the analysis of existing parameters and of new weight-at-length data (Froese et al., 2014). In FishBase, the Bayesian approach has been also used in the analysis of LWRs for estimating LWR for species for which this information is not available by using over 5,000 LWR records for over 1,800 species (Froese et al., 2014). In this review, we gathered 102 LWRs from the literature comprising of 64 freshwater fish species from Malaysian inland waters in order to determine their robustness and condition.

MATERIAL AND METHODS

All fish LWRs presented here are collected data of field studies conducted during 2000-2015 in freshwaters environment of Malaysia, and are consistent with the format suitable for inclusion in FishBase. The sources of these LWRs are gathered from various journals and technical reports. The majority of the original LWRs stated in this study were presented in $W = aL^b$ equation form. But, there were several studies that provide a and b values only without the full equation. To standardize the review, the value was arranged in $W = aL^b$ equation form. All reported a and b values are analysed to obtain the descriptive statistical analysis (mean, minimum and maximum values). Ten fish species that have three or more LWRs were chosen to be compared with Bayesian LWRs obtained from FishBase (Froese and Pauly, 2016).

RESULTS AND DISCUSSION

A total of 102 LWRs were gathered from the literatures, referring to 64 species and belonging to 20 families of Malaysian fresh water fishes (Tab. 1). The value of the slope of regression, b , in the plot of $\log W$ against $\log L$ ranged from 2.190 for *Clarias batrachus* collected in Pahang, to 4.106 for *Barbodes binotatus* collected from Kerian River, Perak. The a value ranged from 0.0011 for *Barbodes binotatus*, collected from Kerian River, Perak, to 0.0933 for *Clarias batrachus* collected from Pahang.

In Malaysia, Cyprinidae is the family most often studied for these LWRs, constituting of 46%, followed by families of Clariidae and Pangasidae (6%), Ambassidae, Bagridae and Sisoridae (5%), Notoperidae and Clupeidae (3%) and only 2% each for Cobitidae, Eleotrididae, Elopidae, Latidae, Megalopidae, Mugilidae, Pristolepididae, Scatophagidae, Schilbeidae, Siluridae and Tetraodontidae. Geographically, 94 (92%) of the LWRs studies have been conducted in West Malaysia compared to East Malaysia, where only eight (8%) studies have been reported. In West Malaysia, 50% of LWR studies were conducted in the East Coast area (Pahang and Terengganu), while Northern states (Perak and Kedah) have contributed to 35% of the studies. The Southern and West Coast area of West Malaysia remain the lowest at about 5% and 2%, respectively.

Table 1: Length-weight relationships of 64 freshwater fishes in Malaysia.

Families	Species	Sampling area	N	<i>a</i>	<i>b</i>	References
Ambassidae	<i>Ambassis interrupta</i>	Lutong River, Sarawak	118	0.0131	2.98	Nyanti et al., 2012
	<i>Ambassis kopsii</i>	Lutong River, Sarawak	43	0.0152	2.94	Nyanti et al., 2012
	<i>Ambassis urotaenia</i>	Lutong River, Sarawak	8	0.0214	2.65	Nyanti et al., 2012
Aariidae	<i>Arius malculatus</i>	Pulai River, Johor	161	0.0295	2.62	Arshad et al., 2008
	<i>Arius tenuispinis</i>	Pulai River, Johor	70	0.0026	2.66	Arshad et al., 2008
	<i>Plicofollis argyropleuron</i>	Kuala Muda and Merbok, Kedah	539	0.0070	3.09	Nor Aziella and Mansor, 2012
Bagridae	<i>Batasio fluviatilis</i>	Pelusi River, Kuala Kangsar	28	0.0323	2.44	Ikhwanuddin et al., 2016
	<i>Hemibagrus nemurus</i>	Pahang River, Temerloh	20	0.0068	3.07	Zulkafli et al., 2015
		Perak*	30	0.0052	3.15	Yusof et al., 2011
		Tembeling River, Pahang	47	0.0064	3.09	Zulkafli et al., 2016
	<i>Pseudomystus siamensis</i>	Negeri Sembilan	30	0.0060	3.20	Yusof et al., 2011
Clariidae	<i>Clarias batrachus</i>	Pahang*	30	0.0933	2.19	Yusof et al., 2011
	<i>Clarias gariepinus</i>	Selangor*	30	0.0138	2.76	Yusof et al., 2011
	<i>Clarias leiacanthus</i>	Pahang River, Maran	34	0.0192	2.75	Zulkafli et al., 2014
	<i>Clarias macrocephalus</i>	Pahang*	30	0.0151	2.79	Yusof et al., 2011
Clupeidae	<i>Anodontostoma chacunda</i>	Pulai River, Johor	133	0.0118	3.09	Arshad et al., 2008
	<i>Hilsa kelee</i>	Pulai River, Johor	499	0.0448	2.54	Arshad et al., 2008
Cobitidae	<i>Acantopsis dialuzona</i>	Kerian River basin, Perak	56	0.0190	2.43	Mohd-Shafiq et al., 2012
Cyprinidae	<i>Amblyrhynchichthys truncatus</i>	Pahang River, Maran	175	0.0047	3.31	Zulkafli et al., 2014
		Pahang River, Temerloh	14	0.0084	3.08	Zulkafli et al., 2015
	<i>Anematachthys repasson</i>	Tembeling River, Pahang	10	0.0063	3.19	Zulkafli et al., 2016
	<i>Barbichthys laevis</i>	Pahang River, Maran	98	0.0124	2.90	Zulkafli et al., 2014
		Tembeling River, Pahang	60	0.0059	3.13	Zulkafli et al., 2016

Table 1 (continued): Length-weight relationships of 64 freshwater fishes in Malaysia.

Families	Species	Sampling area	N	a	b	References
Cyprinidae	<i>Barbodes binotatus</i>	Kerian River, Perak	76	0.0011	4.11	Isa et al., 2010
		Langkawi Island, Perak	49	0.0130	2.99	Samat et al., 2012
		Kerian River basin, Perak	92	0.0500	3.81	Mohd-Shafiq et al., 2012
		Pelus River, Kuala Kangsar	16	0.0062	3.30	Ikhwanuddin et al., 2016
	<i>Barbonymus gonionotus</i>	Pedu Lake, Kedah	32	0.0058	3.23	Isa et al., 2010
	<i>Barbonymus schwanefeldii</i>	Pedu Lake, Kedah	246	0.0168	2.86	Isa et al., 2010
		Pahang River, Maran	145	0.0112	3.08	Zulkafli et al., 2014
		Tembeling River, Pahang	124	0.0162	2.93	Zulkafli et al., 2016
		Pahang River, Temerloh	88	0.0141	3.00	Zulkafli et al., 2015
	<i>Chela</i> sp.	Pedu Lake, Kedah	88	0.0158	2.67	Isa et al., 2010
	<i>Cirrhinus caudimaculatus</i>	Tembeling River, Pahang	152	0.0067	3.08	Zulkafli et al., 2016
	<i>Crossocheilus atrilimes</i>	Pelus River, Kuala Kangsar	36	0.0062	3.09	Ikhwanuddin et al., 2016
	<i>Cyclocheilichthys apogon</i>	Kerian River, Perak	46	0.0033	3.51	Isa et al., 2010
		Kerian River basin, Perak	56	0.0020	3.63	Mohd-Shafiq et al., 2012
		Temengor Reservoir, Perak	233	0.0080	3.16	Muzzalifah et al., 2015
	<i>Cyclocheilichthys apogon</i>	Pahang River, Maran	203	0.0071	3.22	Zulkafli et al., 2014
		Tembeling River, Pahang	215	0.0072	3.15	Zulkafli et al., 2016
		Pahang River, Temerloh	48	0.0095	3.05	Zulkafli et al., 2015
	<i>Devario regina</i>	Pelus River, Kuala Kangsar	58	0.0132	2.82	Ikhwanuddin et al., 2016
		Kerian River, Perak	112	0.0057	3.3	Isa et al., 2010
		Langkawi Island, Perak	52	0.0080	3.06	Samat et al., 2012
		Kerian River basin, Perak	124	0.0130	3.25	Mohd-Shafiq et al., 2012
	<i>Hampala macrolepidota</i>	Kenyir Lake, Terengganu	2057	0.0148	2.88	Zakaria et al., 2000
Temengor Reservoir, Perak		207	0.0100	3.02	Muzzalifah et al., 2015	
Tembeling River, Pahang		23	0.0105	2.99	Zulkafli et al., 2016	

Table 1 (continued): Length-weight relationships of 64 freshwater fishes in Malaysia.

Families	Species	Sampling area	N	<i>a</i>	<i>b</i>	References
Cyprinidae	<i>Hypsibarbus pierrei</i>	Pahang River, Maran	60	0.0115	3.03	Zulkafli et al., 2014
	<i>Hypsibarbus wetmorei</i>	Pahang River, Maran	231	0.0079	3.15	Zulkafli et al., 2014
		Tembeling River, Pahang	19	0.0118	3.01	Zulkafli et al., 2016
		Pahang River, Temerloh	49	0.0094	3.11	Zulkafli et al., 2015
	<i>Labiobarbus festivus</i>	Pahang River, Temerloh	56	0.00892	3.00	Zulkafli et al., 2015
		Tembeling River, Pahang	103	0.0072	3.07	Zulkafli et al., 2016
	<i>Labiobarbus leptocheilus</i>	Kerian River basin, Perak	104	0.0280	2.86	Mohd-Shafiq et al., 2012
		Temengor Reservoir, Perak	73	0.0150	2.85	Muzzalifah et al., 2015
	<i>Labiobarbus lineatus</i>	Kerian River, Perak	58	0.0095	2.99	Isa et al., 2010
	<i>Luciosoma setigerum</i>	Pahang River, Temerloh	9	0.0088	2.86	Zulkafli et al., 2015
	<i>Mystacoleucus marginatus</i>	Tembeling River, Pahang	32	0.0074	3.17	Zulkafli et al., 2016
	<i>Mystacoleucus obtusirostris</i>	Pedu Lake, Kedah	65	0.0230	2.70	Isa et al., 2010
		Pahang River, Maran	31	0.0137	2.94	Zulkafli et al., 2014
		Temengor Reservoir, Perak	83	0.0070	3.15	Muzzalifah et al., 2015
	<i>Neolissochilus hexagonolepis</i>	Pelus River, Kuala Kangsar	128	0.0099	3.04	Ikhwanuddin et al., 2016
	<i>Osteochilus microcephalus</i>	Pedu Lake, Kedah	35	0.0075	3.05	Isa et al., 2010
	<i>Osteochilus vittatus</i>	Temengor Reservoir, Perak	357	0.0100	3.04	Muzzalifah et al., 2015
		Pahang River, Maran	89	0.0093	3.12	Zulkafli et al., 2014
		Tembeling River, Pahang	10	0.0168	2.85	Zulkafli et al., 2016
		Pahang River, Temerloh	19	0.0137	2.93	Zulkafli et al., 2015
	<i>Osteochilus waandersii</i>	Pahang River, Temerloh	24	0.0075	3.12	Zulkafli et al., 2015
	<i>Oxygaster anomalura</i>	Temengor Reservoir, Perak	171	0.0200	2.60	Muzzalifah et al., 2015
	<i>Puntioplites bulu</i>	Pahang River, Maran	43	0.0108	3.04	Zulkafli et al., 2014
Tembeling River, Pahang		18	0.0119	3.01	Zulkafli et al., 2016	
<i>Puntioplites proctozysson</i>	Tembeling River, Pahang	241	0.0087	3.15	Zulkafli et al., 2016	
<i>Probarbus jullieni</i>	Pahang River, Maran	89	0.0080	3.09	Zulkafli et al., 2014	

Table 1 (continued): Length-weight relationships of 64 freshwater fishes in Malaysia.

Families	Species	Sampling area	N	<i>a</i>	<i>b</i>	References
Cyprinidae	<i>Rasbora sumatrana</i>	Kerian River, Perak	77	0.0025	3.61	Isa et al., 2010
		Kerian River basin, Perak	92	0.0110	3.30	Mohd-Shafiq et al., 2012
	<i>Thynnichthys thynnoides</i>	Pahang River, Temerloh	43	0.0114	2.92	Zulkafli et al., 2015
		Pahang River, Maran	52	0.0063	3.13	Zulkafli et al., 2014
Eleotrididae	<i>Oxyeleotris marmorata</i>	Pahang River, Maran	30	0.0049	3.28	Zulkafli et al., 2014
Latidae	<i>Lates calcarifer</i>	Lutong River, Sarawak	10	0.0144	3.02	Nyanti et al., 2012
Mugilidae	<i>Liza melinoptera</i>	Lutong River, Sarawak	8	0.0149	2.95	Nyanti et al., 2012
Megalopidae	<i>Megalops cyprinoides</i>	Lutong River, Sarawak	24	0.0173	2.79	Nyanti et al., 2012
Notopteridae	<i>Chitala Lopis</i>	Pahang River, Maran	33	0.0173	2.69	Zulkafli et al., 2014
	<i>Notopterus Notopterus</i>	Pedu Lake, Kedah	120	0.0036	3.25	Isa et al., 2010
Pangasiidae	<i>Pangasianodon hypophthalmus</i>	Pahang River, Maran	24	0.0227	2.75	Zulkafli et al., 2014
	<i>Pangasius pangasius</i>	Perak*	30	0.0290	2.72	Yusof et al., 2011
	<i>Pangasius nasutus</i>	Selangor*	30	0.0479	2.57	Yusof et al., 2011
		Pahang River, Maran	24	0.0045	3.16	Zulkafli et al., 2014
	<i>Pseudolais micronemus</i>	Pahang River, Maran	46	0.0069	3.02	Zulkafli et al., 2014
		Pahang River, Temerloh	33	0.0071	3.00	Zulkafli et al., 2015
Tembeling River, Pahang		143	0.0105	2.88	Zulkafli et al., 2016	
Pristolepididae	<i>Pristolepis fasciata</i>	Temengor Reservoir, Perak	31	0.0180	3.07	Yusof et al., 2011
		Pahang River, Maran	43	0.0160	3.12	Zulkafli et al., 2014

Table 1 (continued): Length-weight relationships of 64 freshwater fishes in Malaysia; note: * denotes no specific area reported by authors.

Families	Species	Sampling area	N	<i>a</i>	<i>b</i>	References
Pristolepididae	<i>Pristolepis fasciata</i>	Temengor Reservoir, Perak	31	0.0180	3.07	Yusof et al., 2011
		Pahang River, Maran	43	0.0160	3.12	Zulkafli et al., 2014
Scatophagidae	<i>Scatophagus argus</i>	Lutong River, Sarawak	16	0.0359	3.03	Nyanti et al., 2012
Schilbeidae	<i>Laiides hexanema</i>	Pahang River, Temerloh	17	0.0070	3.09	Zulkafli et al., 2015
		Pahang River, Maran	120	0.0043	3.24	Zulkafli et al., 2014
Siluridae	<i>Phalacronotus apogon</i>	Pahang River, Maran	49	0.0258	2.43	Zulkafli et al., 2014
		Tembeling River, Pahang	25	0.0049	3.08	Zulkafli et al., 2016
Sisoridae	<i>Bagarius yarrelli</i>	Pahang River, Temerloh	14	0.0146	2.72	Zulkafli et al., 2015
	<i>Glyptothorax major</i>	Pelus River, Kuala Kangsar	62	0.0074	3.15	Ikhwanuddin et al., 2016
	<i>Glyptothorax siamensis</i>	Pelus River, Kuala Kangsar	23	0.0089	2.98	Ikhwanuddin et al., 2016
Tetraodontidae	<i>Arothron reticularis</i>	Lutong River, Sarawak	9	0.0359	2.95	Nyanti et al., 2012

From a total of 13 conducted previous studies, it can be listed that 32 fish species from 47 LWR studies experienced positive allometric growth, where 20 fish species from 23 LWR studies experienced isometric growth and 28 fish species from 31 LWR studies experienced negative allometric growth (Fig. 1). However, there were also different types of growth suggested by researchers for the same species. For instance, the growth pattern of *Barbodes binotatus* was isometric in Langkawi Island as reported by Samat et al. (2012), but Isa et al. (2010) and Mohd-Shafiq et al. (2010) recorded positive allometric growth for this species. These observations were also identified for 12 more species, such as *Barbonymus schwanefeldii*, *Barbichthys laevis*, *Labiobarbus festivus*, *Thynnichthys thynnoides*, *Devario regina*, *Hypsibarbus wetmorei*, *Pseudolais micronemus*, *Hampala macrolepidota*, *Mystacoleucus obtusirostris*, *Osteochilus vittatus*, *Phalacronotus apogon* and *Pangasius nasutus*. These findings might be due to different habitat conditions in terms of variations of food supply which influences the habitual preferences of the fish, fish activities, and feeding habits of fish species (Mizuno and Furtado, 1982; Lowe-McConnell, 1987).

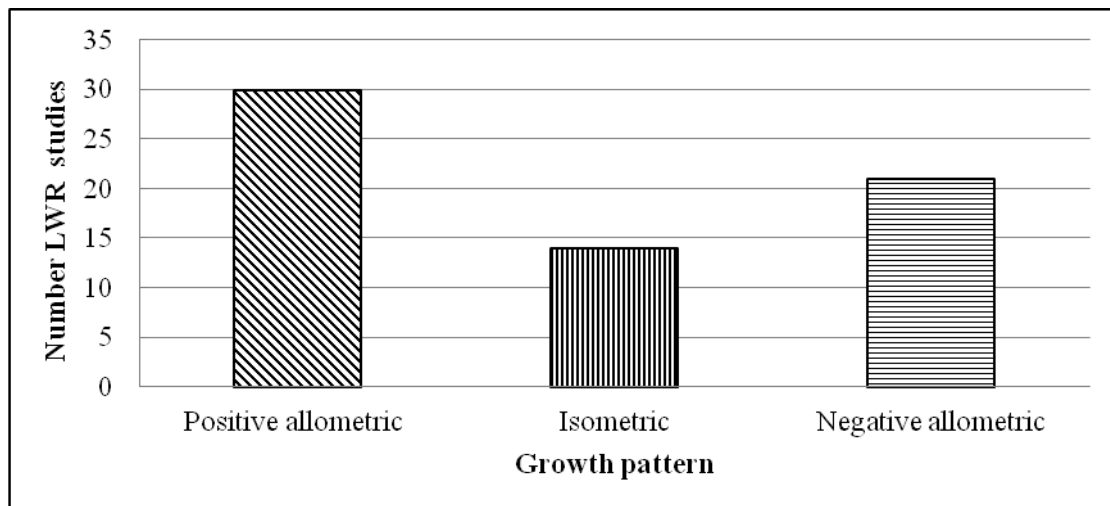

Figure 1: Growth patterns of 64 freshwater fishes from 102 length-weight relationships studies in Malaysia.

The mean for a value from 64 LWRs was 0.0136, and ranging from 0.0011 for *Barbodes binotatus* collected in Kerian River, Perak, to 0.0933 for *Clarias batrachus* collected in Pahang. By referring to Froese and Pauly (2015), body type of all 64 species were determined (Tab. 2). From 64 species, there were 11 (17%) species that have elongated body type, 30 (47%) have fusiform body type and the other 22 (36%) species showed short and deep body type (Fig. 2). In term of the fish families, there were 15 families that exhibit short and deep body type, eight have fusiform and only six have elongated body type. There were three families (Aaridae, Cyprinidae and Sisoridae) that have multiple body types for different species of fishes. Eel-like body type is absent from the result because there was no a value that fit in the category (Tab. 2). It is important to note that fusiform is the most general body type and ideal for free swimming species (Khanna, 2004), compared to other body types. Helfman et al. (2009) stated that body type is one of the factors that help fish swim faster, thus determining their feeding habits and desired habitat.

The mean of b value for 64 LWR studies of 49 freshwater fishes in Malaysia was 3.0139, which indicated that their growth is still in the normal range for freshwater fish. Froese (2006) has confirmed that expected range of b is $2.5 < b < 3.5$. From the results, it is also necessary to study more about negative allometric growth (20 species), whether they are genuinely affected by environmental condition or statistical inaccuracy due to inadequate LWR data collection. However, according to Copp et al. (2013), the isometric body growth of *Barbatula barbatula* changes to allometric type when it reaches a certain standard length in order to become an adult. This indicates that body growth type sometimes changes accordingly to their physiology needs.

Low catch of fish species may be contributed by the unsuitable fishing gear used or inadequate and unfit timing. The number of sample size also affects the quality of the relationships. Only $n > 10$ should be accepted because Central Limit Theorem has been used. Also note that sampling distribution of the sample mean will approximately become normal as the sample size increases. Thus, the value of n below 10 will not provide a good approximation to the probability of interest (Kenneth, 2007). It is important to note that there are 14 LWRs that have regression value below than 0.9 ($R^2 < 0.9$). For example, *Ambassis urotaenia* have very small sample size ($n = 8$), which could have answered its low regression value ($R^2 = 0.850$) and considered statistically low for LWR study. In contrast, even a total of 70 individuals of *Arius tenuispinis* have been recorded, but the R^2 value is only recorded at 0.850. The condition is same with *Chela* sp., *Devario regina*, *Mystacoleucus obstusirostris*, *Osteochilus microcephalus*, *Lates calcarifer*, *Megalops cyprinoides*, *Rasbora sumatrana*, *Pangasius pangasius* and *Pangasius nasutus*. Moreover, even though sample size for *Luciosoma setigerum*, *Liza melinoptera* and *Arothron reticularis* are low ($n < 10$), the R^2 value is significantly strong. Kelley and Preacher (2012) stated that these observation sometimes due to a small sized sample is sometimes considered enough for certain fish species. Besides that, possibilities of human error (data collection, recording or entry) and inconsideration of outliers in the LWR calculation (Osborne et al., 2004) also makes the R^2 value lower, resulting in less confidence in the information.

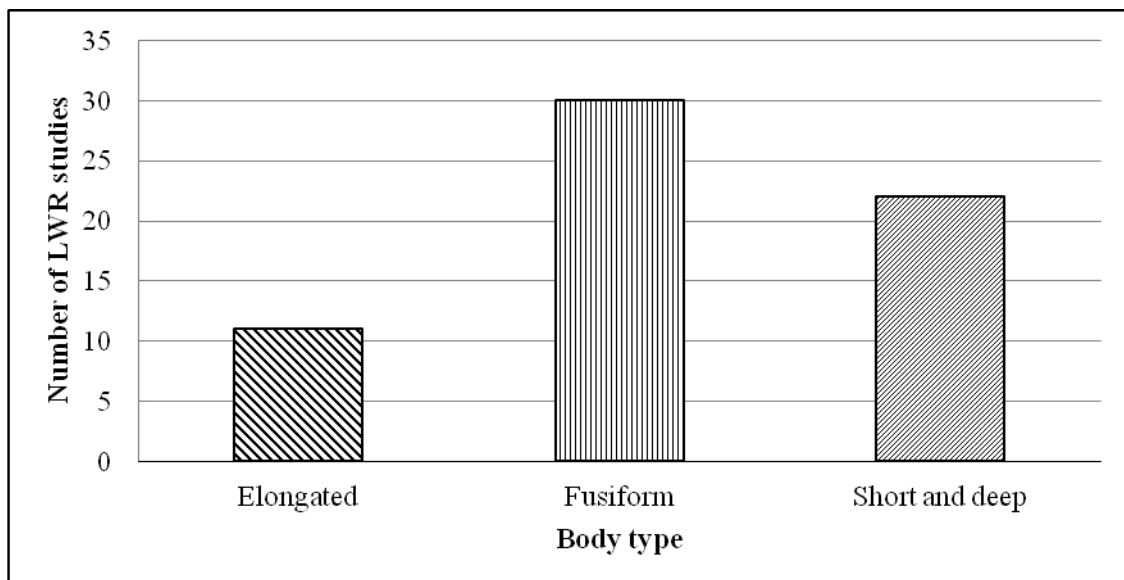

Figure 2: Body type of 64 freshwater fishes from 102 length-weight relationships studies in Malaysia.

Table 2: Estimation of body shape mean by following Bayesian length-weight relationship (Froese and Pauly, 2015).

Body shape	Prior for b (mean \pm SD)	Prior of $\log_{10}(a)$ (mean \pm SD)
Eel-like	3.06 \pm 0.0896	- 2.99 \pm 0.175
Elongated	3.12 \pm 0.09	- 2.41 \pm 0.171
Fusifiform	3.04 \pm 0.0857	- 1.95 \pm 0.173
Short and deep	3.01 \pm 0.0905	- 1.7 \pm 0.175

Ten fish species that have three or more LWRs were chosen for comparison with FishBase Bayesian database in order to analyse the similarity of a and b value average and range between both methods. Only four species, namely *Hemibagrus nemurus*, *Hampala macroleidata*, *Mystacoleucus obstusirostris*, and *Osteochilus vittatus*, were available in the FishBase database. From the four species, only *Hemibagrus nemurus* observed within the Bayesian LWR range (Tab. 3). This condition may be related to lack of data of those species to calculate the range more accurately. Bayesian LWR needs a significant number of baseline data to create a meaningful mean of 95% High Density Interval of a and b values (Froese et al., 2014). Unfortunately, Cole-Fletcher et al. (2011) have observed some flaw on FishBase's LWR database where studied species minimum and maximum curves produced with the length-weight parameters at FishBase.org are notably different from each other, and in many cases predict weights that are clearly absurd. Hence, to utilize FishBase database, a few statistical tests and corrections need to be conducted to ensure the accuracy of data presentation.

Table 3: Comparison of a and b values range between normal and Bayesian length-weight relationship of four selected species.

Species	a value LWR range	95% of HDI of a value	b value LWR range	95% of HDI of b value	In range?
<i>Hemibagrus nemurus</i>	0.0052- 0.00677	0.00379- 0.00978	3.07- 3.151	2.99- 3.26	Yes
<i>Hampala macroleidata</i>	0.0100- 0.148	0.00907- 0.0235	2.884- 3.019	2.92- 3.18	No
<i>Mystacoleucus obstusirostris</i>	0.0070- 0.0230	0.00608- 0.0214	2.704- 3.147	2.85- 3.15	No
<i>Osteochilus vittatus</i>	0.0093- 0.0168	0.0075- 0.0227	2.85- 3.120	2.97- 3.24	No

CONCLUSIONS

The majority of freshwater fishes in Malaysia have fusiform body type based on mean value of a . The mean of b value for 64 LWRs studies for 49 freshwater fishes in Malaysia was 3.0139. It showed that their growth is still in the normal range for freshwater fish. Thus, it can be concluded that growth pattern for freshwater fish in Malaysia can be considered good even though some changes in b value within these fish species were identified. The fish LWRs observed can be used as an indicator of environmental changes and fish ecological health for freshwater fishes in Malaysia.

ACKNOWLEDGEMENTS

We would like to send our appreciation to members of Aquatic Laboratory, faculty of Environmental Studies, UPM for helping the team. This study was sponsored by UPM Putra Grant GPM/2013/9422500 (Universiti Putra Malaysia).

REFERENCES

1. Adaka G., Ndukwe E. and Nlewadim A., 2015 – Length-weight relationship of some fish species in a tropical rainforest river in southeast Nigeria, *Transylvanian Review of Systematical and Ecological Research, The Wetlands Diversity*, 17.2, 73-78.
- Arshad A., Jimmy A., Nurul Amin S. M., Japar Sidik B. and Harah Z. M., 2008 – Length-weight and length-length relationships of five fish species collected from seagrass beds of the Sungai Pulai estuary, Peninsular Malaysia, *Journal of Applied Ichthyology*, 24, 328-329.
2. Atama C. I., Okeke O. C., Ekeh F. N., Ezenwaji N. E., Onah I. E., Ivoke N. and Eyo J. E., 2013 – Length-weight relationship and condition factor of six cichlid (cichlidae, perciformes) species of Anambra River, Nigeria, *Journal of Fisheries and Aquaculture*, 4, 82-86.
3. Bagenal T. B. and Tesch F. W., 1978 – Aspects of fish fecundity in ecology of freshwater fish production, in *Methods for assessment of fish production in freshwater*, 3rd edition, Oxford, Blackwell Scientific Publications, 75-101.
4. Bowen Z. H., Bovee K. D. and Waddle T. J., 2003 – Effect of flow regulation on shallow water habit dynamics and floodplain connectivity, *Transactions of the American Fisheries Society*, 132, 809-823.
5. Chew P. C. and Zulkafli A. R., 2007 – Sperm cryopreservation of some freshwater fish species in Malaysia, in *Current Frontiers in Cryopreservation*, InTech, 269-292.
6. Chong V. C., Lee P. K. Y. and Lau C. M., 2010 – Diversity, extinction risk and conservation of Malaysian fishes, *Journal of Fish Biology*, 76, 2009-2066.
7. Cole-Fletcher S., Marin-Salcedo L., Rana A. and Courtney M., 2011 – Errors in Length-weight Parameters at FishBase.org, *Nature Precedings*, 1-7.
8. Copp G. H., Vladimir K. and Hensel K., 2013 – When do fishes become juveniles?, *Developments in Environmental Biology of Fishes*, 19, Springer Science and Business Media, 286.
9. Francis R. A., 2012 – A handbook of global freshwater invasive species, Oxon, Routledge, 456.
10. Froese R., 2006 – Cube law, condition factor and weight-length relationships: history, meta-analysis and recommendations, *Journal of Applied Ichthyology*, 22, 241-253.
11. Froese R. and Pauly D., 2015 – FishBase, Retrieved September 21, 2015, from www.fishbase.org
12. Froese R. and Pauly D., 2016 – FishBase, Retrieved January 21, 2016, from www.fishbase.org
13. Froese R., Thorson J. T. and Reyes R. B., 2014 – A Bayesian approach for estimating length-weight relationships in fishes, *Journal of Applied Ichthyology*, 30, 78-85.
14. Helfman G. S., Collette B. B. and Facey D. E., 2009 – The diversity of fishes, West Sussex, United Kingdom, John Wiley and Sons, 736.
15. Hilborn E. and Walters C. J., 2001 – Quantitative fisheries stock assessment: choice, dynamics and uncertainty, New York, Chapman and Hall, 570.
16. Ikhwanuddin M. E. M., Amal M. N. A., Shohaimi S., Azizul A., Johari S., Abdullah T. and Jamil N. R., 2016 – Length-weight relationships of seven fish species from upper Perlus River, Kuala Kangsar District, Perak, Malaysia, *Journal of Applied Ichthyology*, 32, 511-512.
17. Isa M. M., Rawi C. S., Rosla R., Anuar S. and Shah M., 2010 – Length-weight relationships of freshwater fish species in Kerian River basin and Pedu Lake, *Research Journal of Fisheries and Hydrobiology*, 5, 1-8.
18. Jones R. E., Petrell R. J. and Pauly D., 1999 – Using modified length-weight relationship to assess the condition of fish, *Aquaculture Engineering*, 20, 261-276.
19. Kelley K. and Preacher K. J., 2012 – On effect size, *Psychological Methods*, 17, 137-152.
20. Kenneth G. G., 2007 – Power and sample size estimation techniques for fisheries management, *North American Journal of Fisheries Management*, 27, 397-404.
21. Khanna D. R., 2004 – Biology of Fishes, Delhi, Discovery Publishing House, 400.
22. Kuikka S., Vanhatalo J., Pulkkinen H., Mantyniemi S. and Corander J., 2014 – Experiences in Bayesian inference in Baltic salmon management, *Statistical Science*, 29, 42-49.

23. Lawson E. O., 2011 – Length-weight relationships and fecundity estimates in mud-skipper, *Periophthalmus papilio* (Bloch and Schneider, 1801) caught from the mangrove swamps of Lagos Lagoon, Nigeria, *Journal of Fisheries and Aquatic Science*, 6, 264-271.
24. Lim K. K. P. and Tan H. H., 2002 – Freshwater fish diversity in Peninsular Malaysia: A review of recent findings, Penang, Penerbit Universiti Sains Malaysia, in Ali A., Rawi C. S. M., Mansor M., Nakamura R., Ramakrishnan S., and Mundkur T. (eds), *Proceedings of the Asian Wetland Symposium*, 2001, The Asian wetlands: Bringing partnerships into good wetland practices, Pulau Pinang, Penerbit, University Sains Malaysia, 461-481.
25. Lowe-McConnell R. H., 1987 – Ecological studies in tropical fish communities, Cambridge: Cambridge University Press, 400.
26. Mizuno N. and Furtado J. I., 1982 – Ecological notes on fishes in Tasik Bera, The Ecology of Freshwater Swamp, Netherlands, Junk W., 321-354.
27. Muzzalifah A. H., Mashhor M. and Siti Azizah M., 2015 – Length-weight relationship and condition factor of fish populations in Temengor Reservoir, *Sains Malaysiana*, 44, 61-66.
28. Nor Aziella M. R. and Mansor M. I., 2012 – Length-weight and length-length relationship of Longsnouted Catfish, *Plicofollis argyroleuron* (Valenciennes, 1840) in the northern part of Peninsular Malaysia, *Tropical Life Sciences Research*, 23, 59-65.
29. Nyanti L., Ling T.-Y. and Jongkar G., 2012 – Fish and crustacean communities and fish length-weight relationship of Lutong River, Miri, Sarawak, Malaysia, *World Journal of Fish and Marine Sciences*, 4, 102-110.
30. Osborne J. W. and Amy O., 2004 – The power of outliers (and why researchers should ALWAYS check for them), *Practical Assessment, Research and Evaluation*, 9, 1-12.
31. Rahel F. J., 2007 – Biogeographic barriers, connectivity and homogenization of freshwater faunas: it's a small world after all, *Freshwater Biology*, 41, 51-54.
32. Ricker W. E., 1975 – Computation and Interpretation of Biological Statistics of Fish Populations, Bulletin of the Fisheries Research Board of Canada, Ottawa, Department of the Environment Fisheries and Marine Service, 191, 382.
33. Samat A., Izzati A. A., Nur-Hasyimah R., Shukor M. N. and Norhayati A., 2012 – Small streams ichthyofauna of Western Langkawi Island, Malaysia, *Malaysian Applied Biology*, 41, 51-54.
34. Santos M. N., Gaspar M. B., Vasconcelos P. and Monteiro C. C., 2002 – Weight-length relationship for 50 selected fish species of the Algarve coast, *Fisheries Research*, 59, 289-295.
35. Vié J.-C., Hilton-Taylor C. and Stuart S. N., 2008 – Wildlife in a Changing World – An Analysis of the 2008 IUCN Red List of Threatened Species, IUCN, Switzerland, 51, 180.
36. Yusof M. F., Siraj S. S. and Daud S. K., 2011 – Length-weight relationships of seven catfish species in Peninsular Malaysia, *Journal of Fisheries and Aquatic Science*, 6, 828-833.
37. Zakaria-Ismail M., 1991 – The fish fauna of the Ulu Endau River System, Johore, Malaysia, *Malayan Nature Journal*, 41, 403-411.
38. Zakaria M. Z., Jalal K. C. A. and Ambak M. A., 2000 – Length-weight relationship and relative condition factor of Sebarau, *Hampala macropleidota* (Van Hasselt) in Kenyir Lake, Malaysia, *Pakistan Journal of Biological Sciences*, 3, 721-724.
39. Zakeyudin M., Isa M. M., Rawi C. M., Shah A.-S. M. and Ahmad A.-H., 2012 – Assessment of suitability of Kerian River tributaries using length-weight relationship and relative condition factor of six freshwater fish species, *Journal of Environment and Earth Science*, 2, 52-61.
40. Zulkafli A. R., Amal M. N. A., Shohaimi S., Mustafa A., Ghani A. H., Hashim S., Hasfairs M. P., 2014 – Length-weight relationships of 20 fish species from Pahang River, Maran District, Pahang, Malaysia, *Journal of Applied Ichthyology*, 31, 409-410.
41. Zulkafli A. R., Amal M. N. A., Shohaimi S., Mustafa A., Ghani A. H., Hashim S. and Ayub S., 2015 – Length-weight relationships of 15 fish species from Tembeling River, Pahang, Malaysia, *Journal of Applied Ichthyology*, 32, 167-168.
42. Zulkafli A. R., Amal M. N. A., Shohaimi S., Mustafa A., Ghani A. H., Ayub S. and Hasfairs, P., 2016 – Length-weight relationships of 13 fish species from Pahang River, Temerloh District, Pahang, Malaysia, *Journal of Applied Ichthyology*, 32, 165-166.

UPPER CARAȘ RIVER (DANUBE WATERSHED) FISH POPULATIONS FRAGMENTATION – TECHNICAL REHABILITATION PROPOSAL

*Răzvan VOICU **, *Doru BĂNĂDUC ***, *Lee Jason BAUMGARTNER ****,
*Liliana VOICU ** and *Angela CURTEAN-BĂNĂDUC ***

* National Institute of Hydrology and Water Management, București-Ploiești Street 97, București, Romania, RO-013686, rznvoicu@yahoo.com, lilianavoicu80@gmail.com

** "Lucian Blaga" University of Sibiu, Faculty of Sciences, Dr. Ion Rațiu Street 5-7, Sibiu, Sibiu County, Romania, RO-550012, ad.banaduc@yahoo.com, angela.banaduc@ulbsibiu.ro

*** Charles Stuart University, Institute for Land, Water and Society, P.O. Box 789, Albury, New South Wales, Australia, lbaumgartner@csu.edu.au

DOI: 10.1515/trser-2018-0006

KEYWORDS: Site of Community Importance, Caraș Gorge, stream, fish, river continuum rehabilitation.

ABSTRACT

We propose a technical solution for fish movement based on the flow of water over a spill threshold. Such barriers are common in the Danube system. The proposed system has a range of operating components which are easily detachable from the spill threshold, are resistant to corrosion and will not harm the fish. In fact, if designed to complement swimming abilities of target fish, it should provide adequate passage for both adults and juveniles. If implemented correctly, the design may offer a solution to help displaced fish recolonize upstream habitats.

RÉSUMÉ: La fragmentation des populations piscicoles du Caraș Supérieur (bassin du Danube) – proposition technique de réhabilitation.

Nous avons proposé une solution technique pour le déplacement des poissons à l'aide de l'écoulement de l'eau au-dessus d'un déversoir. Des tells **barrières** sont fréquents dans le système hydrographique du Danube. Le système proposé est formé d'une série de composantes opérationnelles facilement détachables du déversoir, résistant à la corrosion et dont la forme ne blesse pas les poissons. En fait, s'il est projeté la capacité de nage des poisson cible aidant, il devrait fournir un passage adéquate pour les adultes ainsi que pour les juvéniles. Si correctement implémenté, le design pout fournir une solution aidant les poisson délocalisées à recoloniser les habitats en amont.

REZUMAT: Fragmentarea populațiilor piscicole de pe Carașul superior (Bazinul Dunării) – propunere tehnică de reabilitare.

Am propus o soluție tehnică pentru deplasarea peștilor cu ajutorul fluxului apei peste un prag deversor. Astfel de bariere sunt frecvent întâlnite în bazinul Dunării. Sistemul propus are o serie de componente de operare care se pot demonta ușor de pe pragul deversor, sunt rezistente la coroziune, iar forma lor nu rănește peștii. Mai mult, dacă este proiectat pentru a veni în întâmpinarea capacității naturale de a înota a peștilor țintă, ar trebui să permită trecerea în condiții adecvate, atât pentru adulți, cât și pentru juvenili. Dacă se implementează în mod corect, proiectul poate fi o soluție pentru a permite recolonizarea habitatelor din amonte de către peștii dislocați din habitat.

INTRODUCTION

Longitudinal and transversal connectivity is essential to ecological functioning in freshwater ecosystems (Aadland 1993, 2010; Barbosa et al., 2001; Sedeno-Diaz and Lopez-Lopez, 2009; Sommerwerk et al., 2010; Bănăduc et al., 2016; Lenhardt et al., 2016). But the construction of dams and weirs can act as migration barriers which prevent organisms, such as fish, to reach critical habitat areas. Fish migration barriers are a main cause of fish communities decline from fragmentation of habitats due to barriers which do not allow downstream fish to move upstream. Employing solutions which facilitate these important migrations are essential, but are not consistently applied. (Larinier, 1983; Katopodis, 1990; O'Doherty, 2009)

Restoring the longitudinal connectivity of the rivers is an essential mechanism to rehabilitate watercourses (Fischer and Cyffka, 2014; Voicu and Breţcan, 2014) and should be a priority for decision-making to protect lotic ecosystems (Kemp and O'Hanley, 2010; Voicu et al., 2015; McKay et al., 2016). Transversal works which lead to the interruption of longitudinal connectivity of rivers is an important issue in Europe (Kay and Voicu, 2013). All river managers must keep or restore longitudinal connectivity in accordance with the Water Framework Directive (Voicu and Merten, 2014). As such, developing new solutions for fish mobility systems over hydrotechnical constructions and improving existing ones is an important priority. Many of such old systems need to be improved, and new designs deployed, in order to help recover fish communities across Europe (Baxter, 1977; Bunn and Arthington, 2002; Voicu and Baki, 2017).

Salmonidae species are well represented in the Romanian Carpathians fauna (six species) in the wild and farmed in fish farms. But weirs and migration barriers are limiting the ability for salmonids to expand distribution throughout Danube tributaries. In spite of this general situation, human activities often fragment their lotic habitats, so that inbreeding and genetic isolation might occur in the wild isolated populations. (Popa et al., 2013, 2016; Nechifor et al., 2017). Solutions need to be found that enable fish to expand their current distribution, facilitate the movements of all size classes and help to overcome migration barriers which cannot be removed.

Caraş River, a tributary of the Danube River, rises on the western side of the Semenic Mountains at around 700 m. The surface of the Caraş Basin on the territory of Romania is 1,118 km² and the length of the river is 80 km. The upper Caraş Basin is characterized by, limestone crossed areas, forming wild gorges with accentuated slopes. The specific multiannual average flow varies between 20 l/s km² in the high mountain range, and below 20 l/s km², up to 7.0 km². There are episodes of very high floods which can displace fish downstream over existing migration barriers. In contrast winter ice-bridges form in 10-15% of winters but only last for a few days (Posea, 1982; Ghinea, 2002). There are many barriers within the Caraş River system which presently preclude the free passage of Salmonidae species from downstream to upstream reaches.

FISH POPULATION IN THE CARAȘ RIVER

The fish fauna of the river Caraș was described more than a half of the century ago by Bănărescu in 1964. The species present in this river in the past were: *Salmo trutta fario* (in its upper course till Carașova locality), *Esox lucius* (from Cacova locality till the Caraș River confluence with the Danube River), *Rutilus rutilus* (in the Oravița area), *Phoxinus phoxinus* (till to the Cacoveni locality), *Tinca tinca* (lower course), *Scardinius erythrophthalmus* (Oravița area), *Squalius cephalus* (Oravița, from Cacoveni), *Alburnus alburnus* (Oravița area), *Alburnoides bipunctatus* (from upstream Carașova), *Blicca bjoerkna* (Oravița area), *Chondrostoma nasus* (from Gârliște), *Rhodeus sericeus* (from Carașova), *Gobio gobio* (from Carașova), *Romanogobio albipinnatus* (from Cacoveni), *Romanogobio kessleri* (at Cacoveni), *Barbus barbus* (from Goruia), *Barbus meridionalis* (from upstream Carașova), *Cyprinus carpio* (in Oravița area), *Carassius carassius* (lower course), *Barbatula barbatula* (from upstream Carașova to Cacoveni), *Misgurnus fossilis* (Oravița area), *Cobitis taenia* (from Cacoveni to the confluence with Danube River), *Sabanejewia balcanica* (from Carașova), *Silurus glanis* (in its lowest part), *Lota lota* (Oravița area), *Perca fluviatilis* (downstream of Cacoveni), *Sander lucioperca* (Oravița area) (Bănărescu, 1964).

The Caraș River fish fauna has significantly changed both due to the appearance of new species including invasive ones and the restriction of some of the native species distribution area, also decreases in the abundance of some species of economic and/or conservation interest. The relatively numerous thresholds and dams without fish passage, pollution, the emergence of some invasive species and poaching have led to these fisheries changes.

The *Salmo trutta fario* population in the Caraș River is characterised by low catches which are dominated by adults (under 5% juveniles). Colonisation of the Caraș River from other streams and rivers is prevented by numerous concrete thresholds and dams, including a series of three downstream of the lower limit of this reach. These obstacles isolate this population preventing upstream colonisation by individuals displaced by floods into downstream inappropriate habitats. The resultant situation is an obvious age class imbalance.

Three concrete thresholds without fish passage presently exist downstream of the Caraș Gorges. These sites would substantially benefit from improved fish passage. Salmonid individuals washed downstream of these barriers are presently unable to move back upstream, and suffer there both the trophic competition of other fish species (the dominant *Barbus meridionalis*, *Alburnoides bipunctatus* and *Phoxinus phoxinus*) and human impact effects. Just two-three km downstream the fish fauna composition (*Barbus meridionalis*, *Alburnoides bipunctatus*, *Orthrias barbatulus*, *Sabanejewia aurata balcanica*, *Gobio gobio*, *Rhodeus sericeus amarus*, *Phoxinus phoxinus*, and *Squalius cephalus*) reveal changings in the lotic habitats which are no more appropriate for salmonids. This study aims to propose some innovative fish passage solutions that could potentially assist salmonid movement in this river reach.

BARRIERS TO FISH MOVEMENT

The first discharge sill is upstream of the other two discharge sills in the existing three series (Fig. 2). It is characterised by a waterfall about 3.5 meters high, about 15 meters long and a crown width about 1.2 meters. At approximately 1.5 meters of the crown inside the discharge sill are two pipes each with 40 cm diameter where flowing are about one m³/s for each pipe (Fig. 3). River slope is roughly 20%. This discharge sill is the first obstacle for *Salmo trutta fario* (Fig. 1a, b) from upstream to downstream, and downstream of the first discharge sill (1). If fish were able to somehow ascend this barrier, then two further upstream barriers must be ascended to reach optimal habitat.



Figure 1a: *Salmo trutta fario* individuals in the researched area.



Figure 1a: *Salmo trutta fario* individuals in the researched area.



Figure 2: Position of Caraș River upstream of Carașova Village.



Figure 3: The first discharge sill threshold and the positioning of the two pipes.



Figure 4: Concrete left bank of the Caraş River upstream of the discharge sill 1.

ACHIEVING FISH PASSAGE AT THESE SITES

It is not possible to remove the three barriers on the Caraş River. Nor is it possible to install a fully engineered technical fishway. We subsequently propose a non-technical fish passage retrofitting option. This will ensure that the existing threshold remains largely in-tact, whilst fish passage is improved.

The first step in achieving a retrofit fish pas at these sites will be to facilitate a breach in the weir face (Figs. 5 and 6). This is essential for water flow into the structure to allow fish to pass whilst taking advantage of the existing operating head.

The breach must have a minimum height of 60 cm, width 40 cm and be higher than the two water pipes. We then propose fixing a semi-rectangular concrete basin (10 cm thick concrete sheet pile) onto the discharge sill. This basin will have two trapezoidal surfaces and be fixed onto the discharge sill 1 and supported by a concrete pillar fixed in the river bed (Fig. 7). Above the semi-rectangular concrete basin will be fixed a transparent and glass sheet pile to protect this basin. An attraction discharge will enter the basin through the two pipes. These works will essentially form a channel that is retrofitted to the weir crest that will facilitate upstream fish movements. The next challenge is to ensure that flows within the channel will complement target species swimming abilities.

From the parallelepiped basin crenel it will be necessary to fit a rectangular channel (module M1) with the same dimensions as the crenel. To maximise cost-effectiveness without compromising function, this rectangular channel (module M1) could be constructed from galvanized metal sheets of 1.5 cm thickness (for structural strength). Ensuring that the channel slope does not exceed that of the river channel aims to match local hydraulics. The challenge will be to ensure that sufficient resting pools are included to enable fish to conserve energy whilst they ascend the structure. The entire structure would be fixed to the threshold 1 by means of metal bars with dowels and at the bottom of the M1 module. Concrete bars could be included where additional strength is required (Fig. 9). High-strength, transparent glass could be included along the full length of module 1 should there be a need to inspect fish as they perform upstream migrations.

Upon completion, the channel could be extended over the concrete left bank and will connect to a rectangular parallelepiped basin 2 fixed on the concrete left bank (Fig. 10).

To achieve a fish free movement system for the beginning, should be made a breach on the discharge sill 1 at approximately three m from the right bank (Figs. 5 and 6).

Breach has a height of 60 cm, width 40 cm and it is higher than the two water pipes. In front of this breach realization on the 1st discharge sill is fixed on the discharge sill a semi-rectangular concrete basin (10 cm thick concrete sheet pile). This basin will have two trapezoidal surfaces that will fit perfectly on the discharge sill 1. This basin will also be supported by a concrete pillar fixed in the river bed (Fig. 7). Above the semi-rectangular concrete basin will be fixed a transparent and very resistant glass sheet pile that protects this basin. Breach will take over some of the flow that flowing through the two pipes.

From the parallelepiped basin crenel start a rectangular channel (module M1) with the same dimensions as the crenel. This rectangular channel (module M1) consists of galvanized metal sheets of 1.5 cm thickness and with a slope that can be to times smaller than the slope of the river. At the top of the M1 module will be fixed to the threshold 1 by means of metal bars with dowels and at the bottom of the M1 module with the help of some concrete bars (Fig. 9). Above this rectangular canal will be placed a high-strength, transparent glass with the length of that of the module 1.

The channel will extend over the concrete left bank and will connect to a rectangular parallelepiped basin 2 fixed on the concrete left bank (Fig. 10).



Figure 5: Upward view of the breach.



Figure 6: Downstream view of the breach.

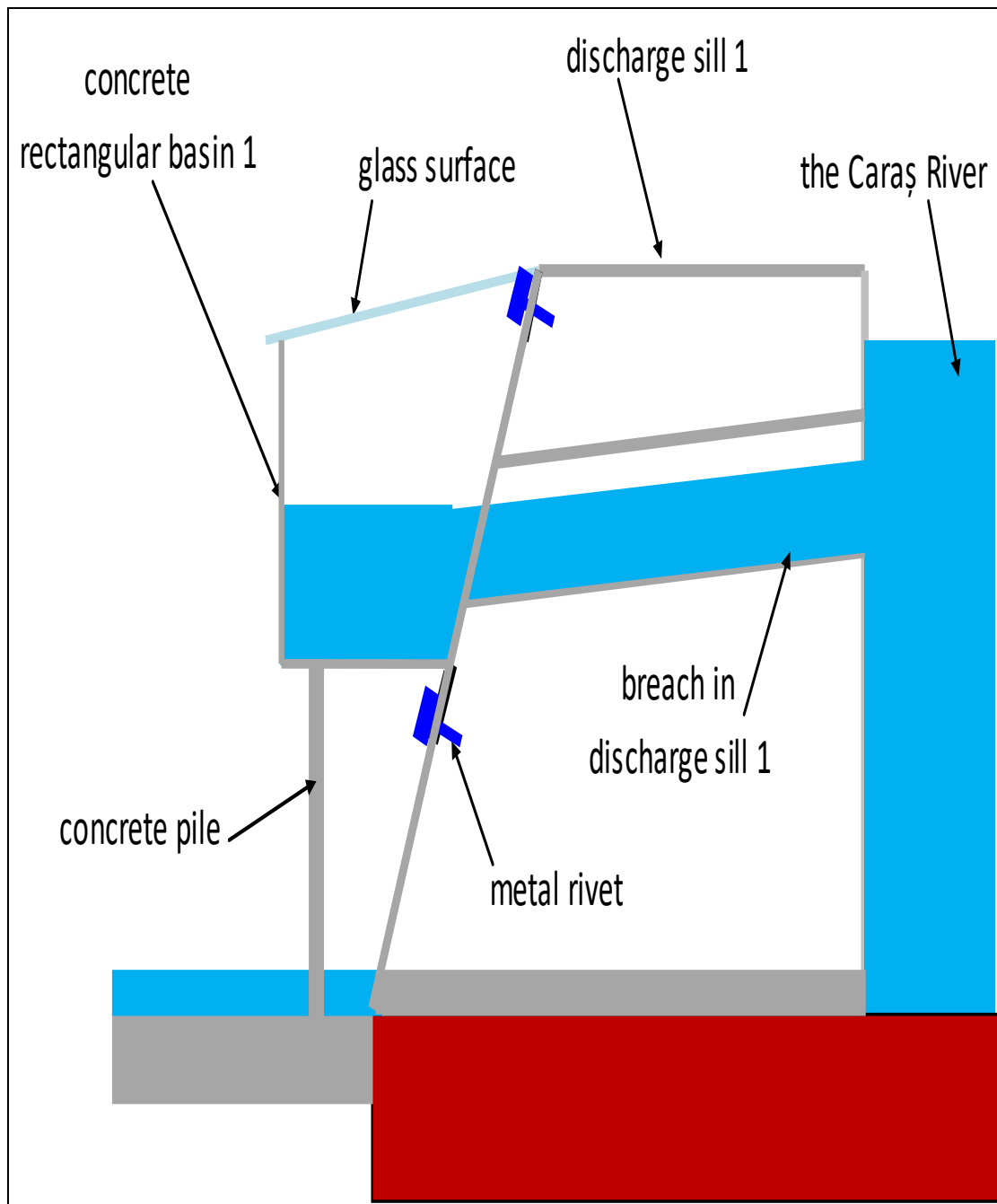

Figure 7: Positioning of the rectangular basin – indicative scheme.

The parallelipipedic basin will have on its surface a crenel with the same dimensions as the breach in threshold 1 (60 cm height, width 40 cm) (Fig. 8). Ensuring the breaches have identical dimensions will ensure a consistent discharge through the new channel.

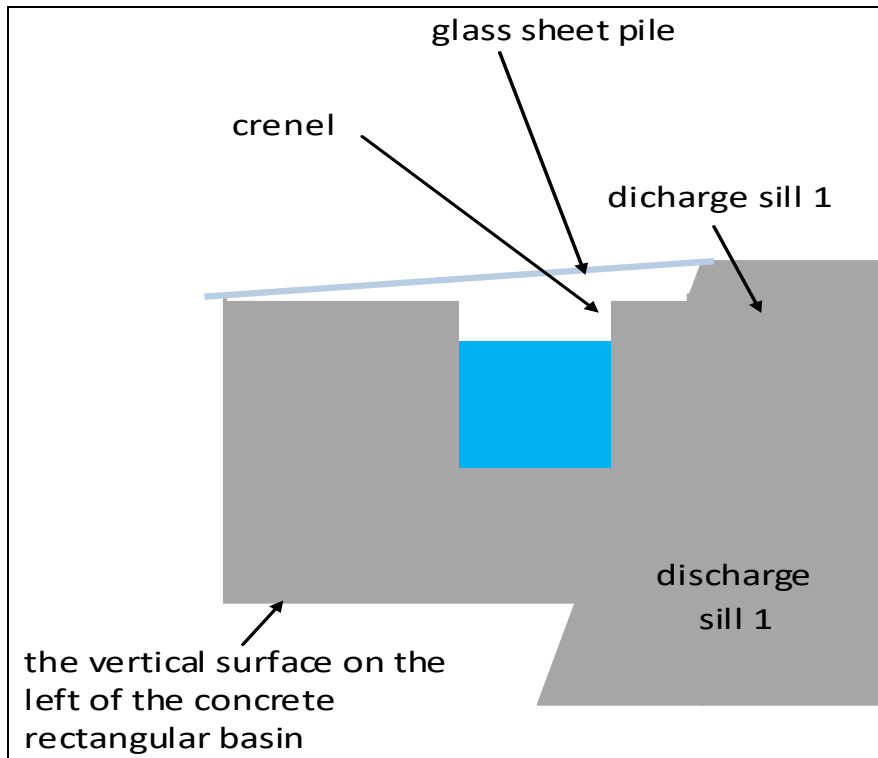

Figure 8: Positioning the crenel in the rectangular basin – indicative scheme.

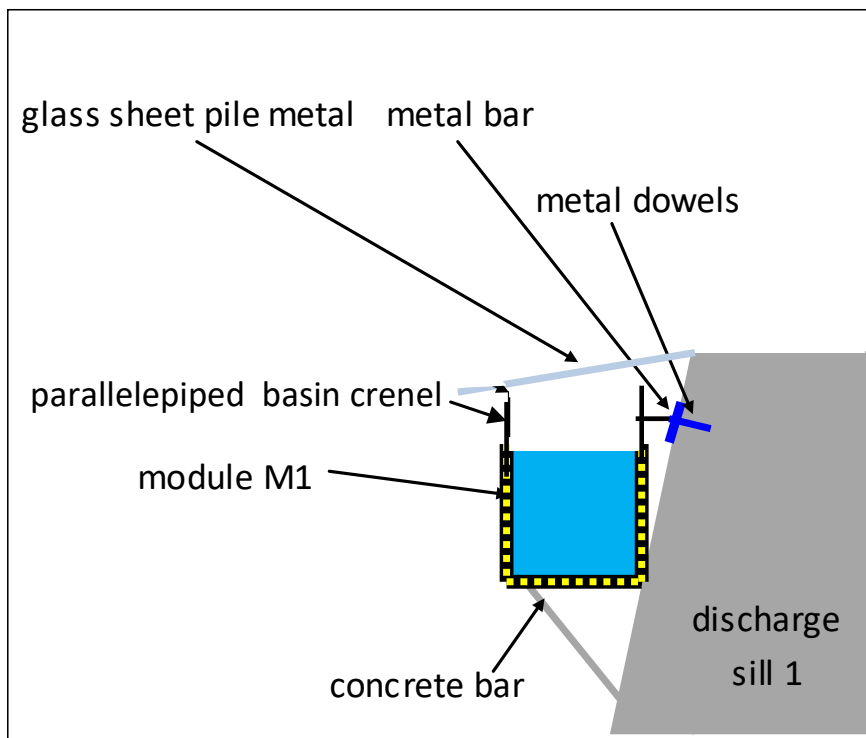

Figure 9: Positioning the rectangular channel in relation to discharge sill 1 – indicative scheme.

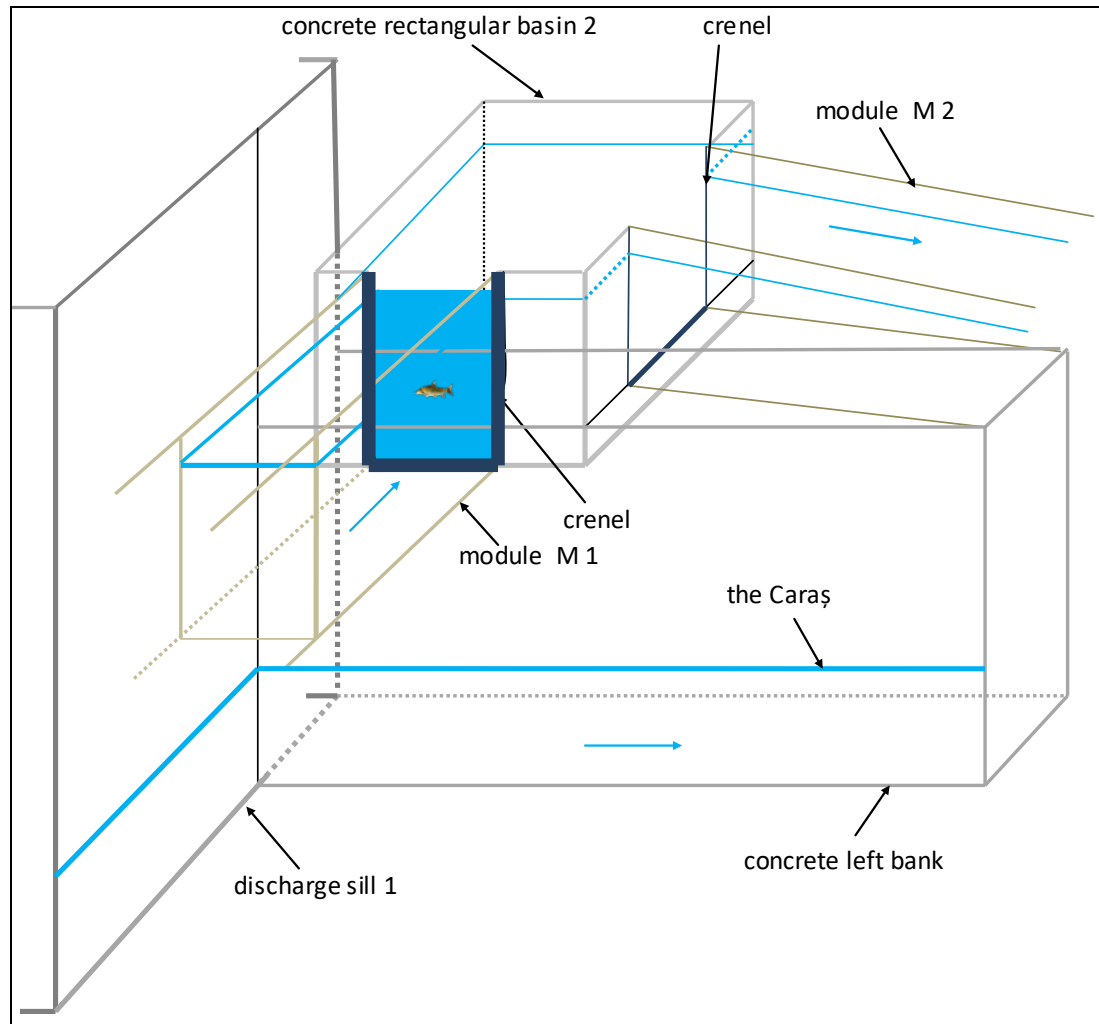

Figure 10: Positioning the second resting basin for fish fauna – indicative scheme.

The rectangular basin 2 (resting pool), which has the role of connecting the M1, M2 and the two rectangular basins (1 and 2), also has a second crenel with the dimensions of the first crenel and the channel dimensions (Module 1). From crenel 2, another channel (Module 2) with the same dimensions as Mod 1 would be installed. Module 2 will extend until the end of the left concrete streambank perhaps tangentially (depending on the slope module). Another rectangular basin 3 (resting pool) will be attached to the concrete left streambank and connected with the M2 module and to the M3 module by another crenel. The crenel will be fixed to the basin 3 by a metal bar which is fixed in two bearings (Fig. 11). Module 3 is formed from two variable geometry modules M3 a and M3 b that can be folded in the event of a flood. The bearings fixed by the basin 3 help to raise the M3a with of a metallic cable with a manual winch or an electric winch set in motion by a level sensor (Fig. 12).

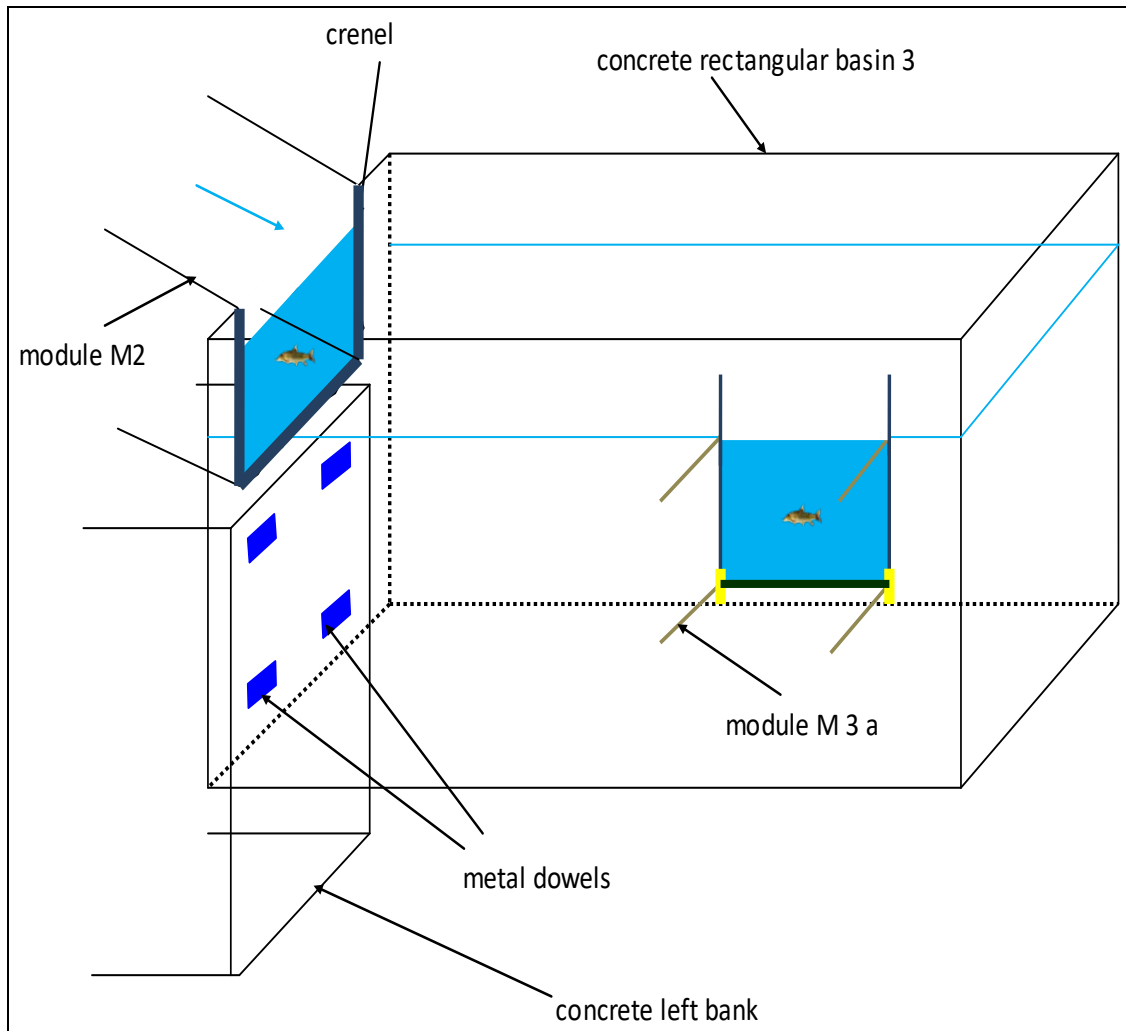

Figure 11: Positioning the second resting basin for fish fauna – indicative scheme.

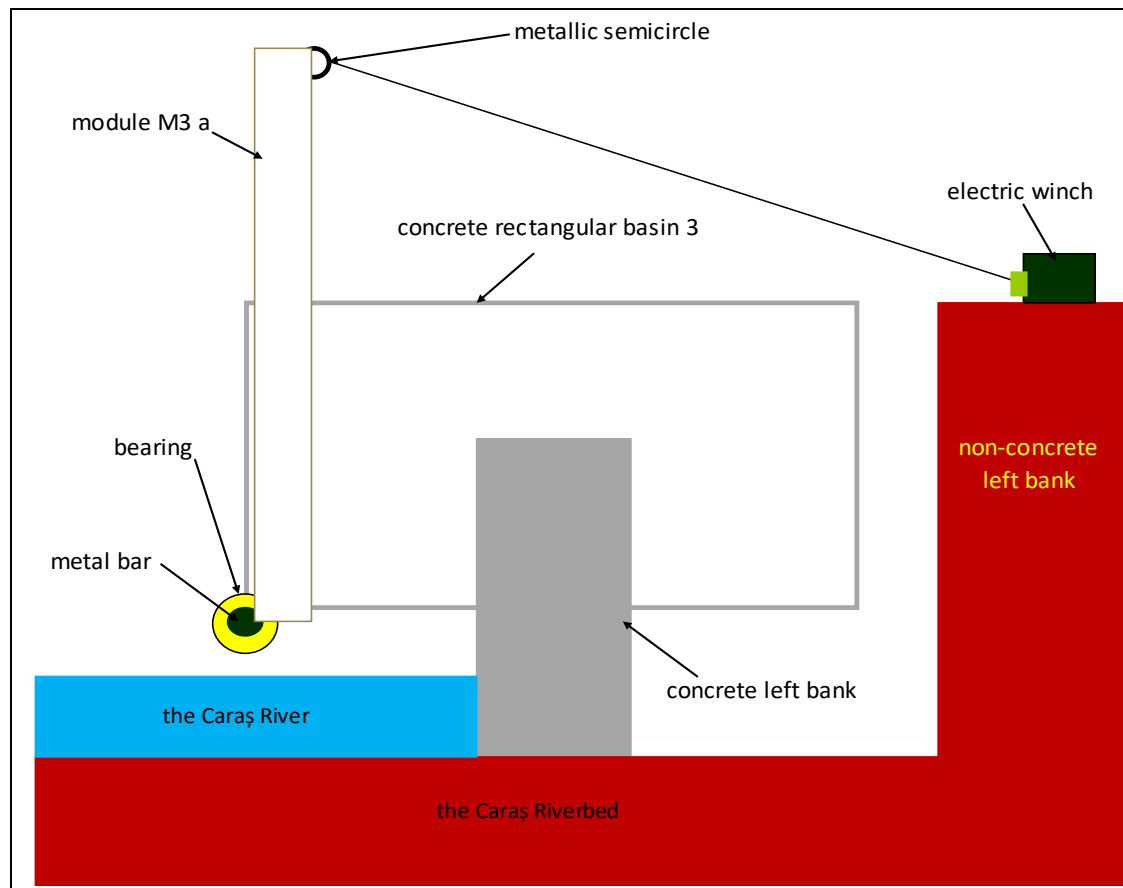

Figure 12: Positioning the electric winch and the metal cable – indicative scheme.

Module 3 will be supported by a single concrete pillar (Fig. 12) and will reach the right bank where the water will be discharged into a rectangular concrete basin 4 (Fig. 13). Rectangular basin 4 will have variable geometry. The basin can be fixed into place by an electric or manually winch equipped with a cable attached to the upstream end of the M3 b module. The point of this section being movable is to ensure that functionality can be maintained under a range of river flows. However, it will require a staff member to manually change the fish pass configuration when river flows change; but will ensure that fish can pass under a range of different flow conditions.

A rectangular semibasin will then be fixed at the end of each two M3a and M3b modules. When swinging on the inclined plane (linear system for fish migration), the two semibasins will align and form one basin of galvanized metal sheet piles of 1.5 cm thickness (Fig. 14). If the two modules do not have variable geometry, floods on Caraș River may destroy them. As such, we offer a design solution here that will enable the channel to pass more flows under high discharge, and lower flows under low discharge, this protecting the integrity of the system and maximising fish passage opportunities during different river discharges.

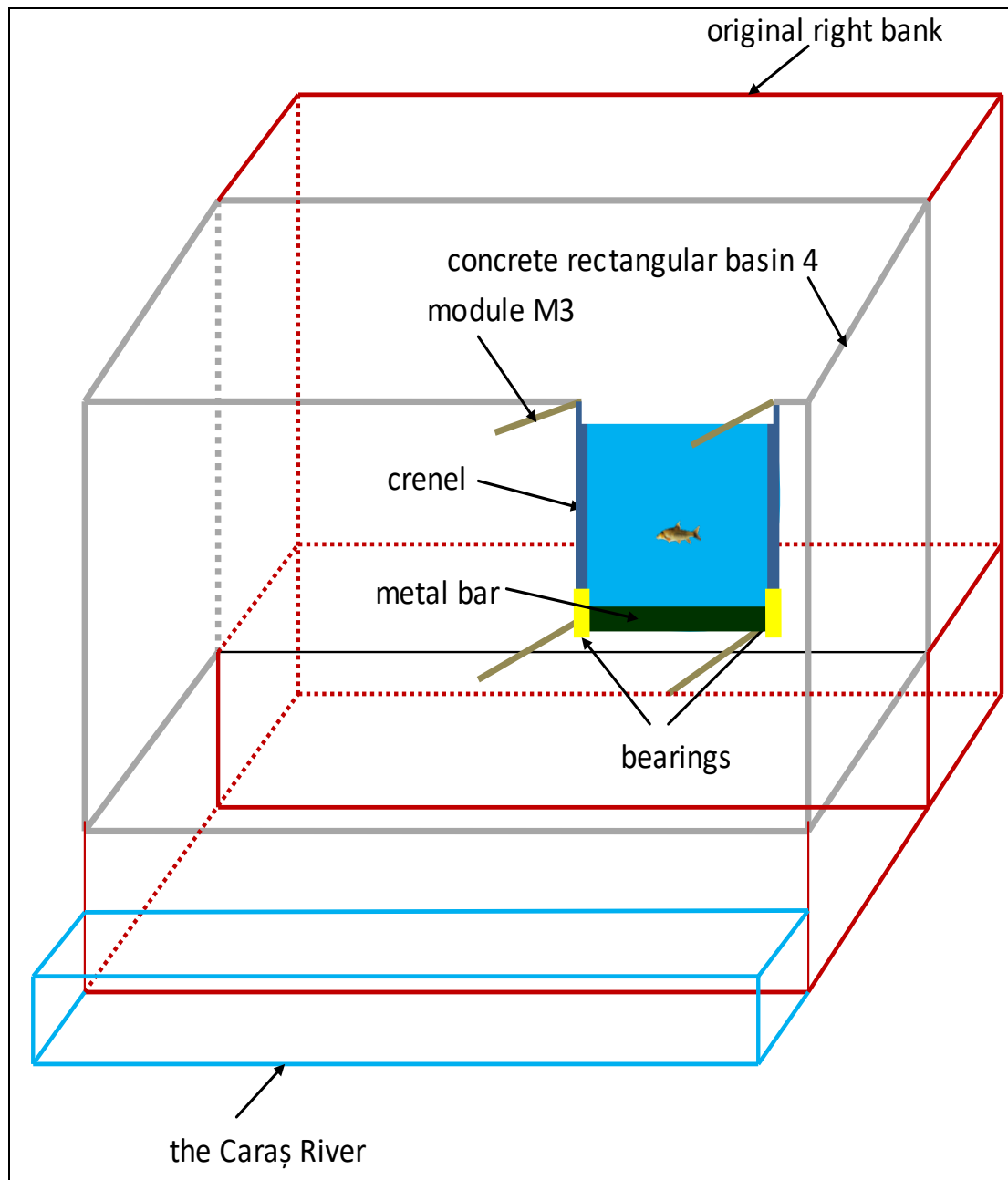

Figure 13: Positioning module M3b in the rectangular concrete basin 4 situated in the right bank – indicative scheme.

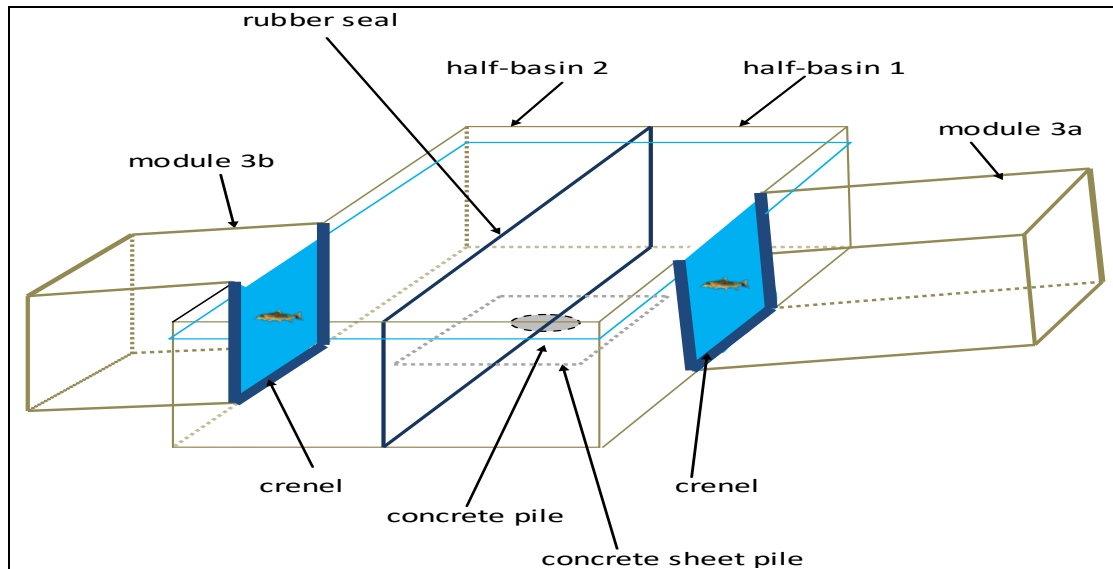

Figure 14: Achieving a resting basin for fish fauna made of two basins – indicative schemes.

The entire system would require a concrete slab (Fig. 14) to support the basin formed by the two semibasins.

This rectangular concrete basin 4 will be directly connected by a crenel with two connection basins with five cm hydraulic jump. If the fishway gradient is set to mimic the natural slope of the river, then a five cm hydraulic jump is well within the limits of swimming abilities as reported in other studies of salmonid swimming ability. So both adult and juvenile species should be able to ascend. The last basin connects directly into the Caraş River (Fig. 15). The connecting basins are also made of concrete sheet piles.

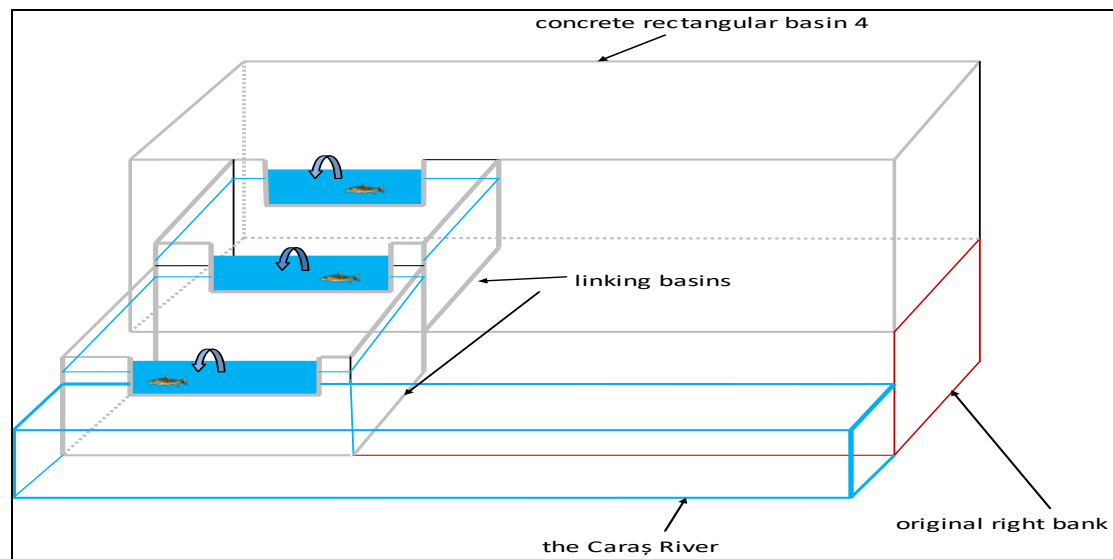

Figure 15: Positioning the linking basins – indicative scheme.

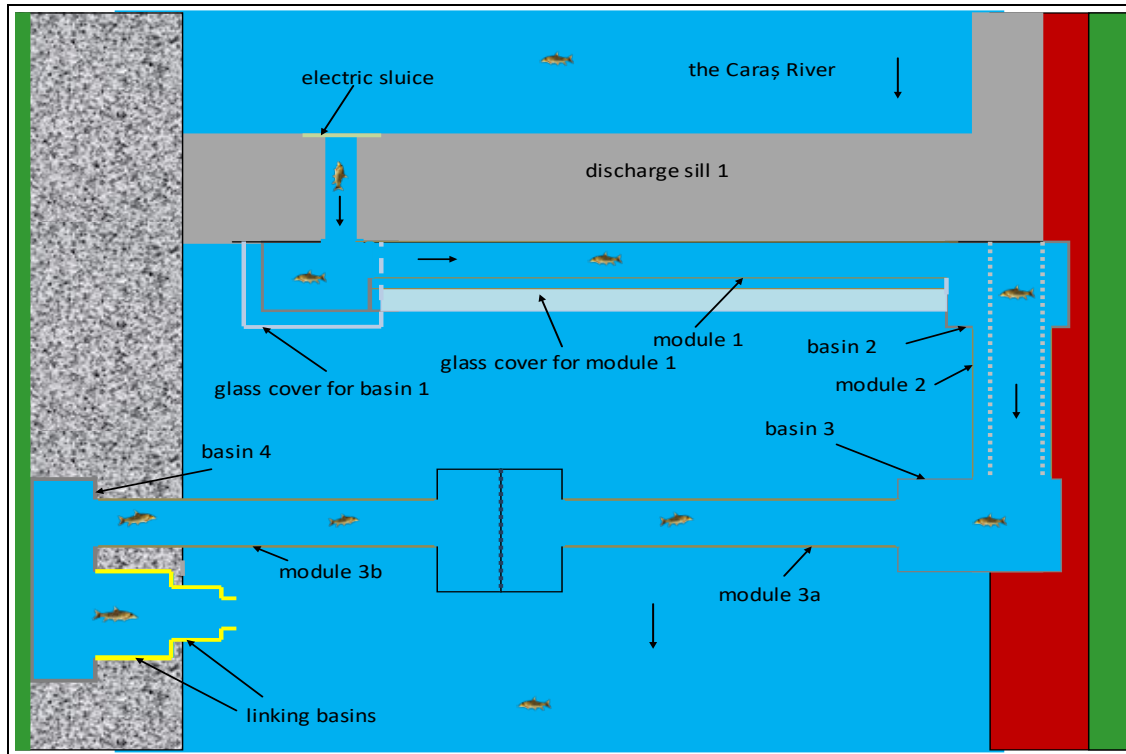

Figure 16: The general scheme of the fish migration system, upstream-downstream of the first discharge sill – indicative scheme.

CONCLUSIONS

Essentially the design we propose is a retrofitted pool and weir fish pass. The main aim of this structure is to allow displaced salmonids to recolonise upstream sections following flooding events (Bănărescu, 1964). In recent times such events happen more frequently when floods emerge from a significant gorge (Bănăduc et al., 2013). By retrofitting a channel to thresholds on the existing weir, we can avoid costly de-watering and coffer damming and only require a small breach of the existing weir structure. It will maintain the integrity of the existing weir and also ensure that the fishway entrance is appropriately placed to maximise fish movements. Importantly, for much of the time all river flow would be directed through the structure by way of existing pipes, thus providing sufficient attractant flow to allow fish to enter the structure.

This proposed technical solution for fish movement over the spill thresholds is entirely based on directing the flow of water to create attraction that provides suitable hydraulic conditions for fish. This system mimics other successful pool and weir designs but has the added benefit of being easily detachable from the spill threshold if required, resistant to corrosion and will provide benefits to fish if internal hydraulic complement fish swimming abilities. Matching the fish pass slope to the overall river gradient should further ensure that both adults and juveniles can pass. Ensuring the fish pass can operate within a head water level variation of one meter will ensure that the need for human intervention to operate the winches would be minimal. As such, understanding the local hydrology would be needed to ensure the final design is grounded within the operational boundaries.

We stress that the solution should be applied within the context of whole-of-system planning. We have focused on only the most downstream barrier in the system, but functional fish passes will be needed on the upstream barriers as well. Such an approach is essential to ensure that all upstream habitats are made available to fish over the long term. It will allow free movement between the Caraş River gorge sectors and the lower ones and other tributaries in the system.

Finally, we stress the need that the construction of any fish ladder must be accompanied by a robust monitoring program to demonstrate that the proposed solution is effective. Any shortcomings can then be repaired and what we learn applied to other sites so that the technology improves into the future. If applied in the context of a whole-of-catchment approach, then fish populations can be expected to improve over the long term.

REFERENCES

1. Aadland L. P., 1993 – Stream habitat types: their fish assemblages and relationship to flow, *North American Journal of Fisheries Management*, 13, 790-806.
2. Aadland L. P., 2010 – Reconnecting rivers: natural channel design in dam removals and fish passage, Minnesota Department of Natural Resources, 15-17.
3. Barbosa F. A. R., Callisto M. and Gáldean N., 2001 – The diversity of benthic macroinvertebrates as an indicator of water quality and ecosystem health: a case study for Brazil, *Aquatic Ecosystem Health and Management*, 4, 51-59.
4. Baxter R. M., 1977 – Environmental effects of dams and impoundments, *Annual Review of Ecology and Systematics*, 8, 255-283.
5. Bănăduc D., Mărginean M. and Curtean-Bănăduc A., 2013 – Geographical and human impact elements influence on the fish fauna of the Olteţ River (Romania), *Transylvanian Review of Systematical and Ecological Research*, 15.2, *The Wetlands Diversity*, Edit. Universităţii "Lucian Blaga" din Sibiu, ISSN 1841-7051, 9-44.
6. Bănăduc D., Rey Planellas S., Trichkova T. and Bănăduc A., 2016 – The lower Danube River-Danube Delta-North West Black Sea: a pivotal area of major interest for the past, present and future of its fish fauna – A short review, *Science of the Total Environment*, 545-546, 137-151.
7. Bănărescu P. M., 1964 – Fauna R. P. Române, Pisces-Osteichthyes, XIII, Edit. Academiei Române, 959. (in Romanian)
8. Bunn S. E. and Arthington A. H., 2002 – Basic principles and ecologic consequences of altered flow regimes for aquatic biodiversity, *Environmental management*, 30, 4, 492-507.
9. Fischer P. and Cyffka B., 2014 – Floodplain restoration on the upper Danube by re-establishing back water dynamics: first results of the hydrological monitoring, *Erkunde*, 68, 1.
10. Ghinea D., 2002 – Enciclopedia geografică a României, Edit. Enciclopedică, Bucureşti, 1456.
11. Katopodis C., 1990 – Advancing the art of engineering fishways for upstream migrants, *Proceedings of International Symposium on Fishways*, Gifu, Japan, 19-28.
12. Kay E. L. and Voicu R. 2013 – Developing an ecological and migration system for ichthyofauna on the Crişul Repede River near the City Hall of Oradea, *Management of Sustainable Development*, Sibiu, Romania, 5, 2, 27-33.
13. Kemp P. S. and O'Hanley J. R., 2010 – Procedures for evaluating and prioritising the removal of fish passage barriers: a synthesis, *Fisheries Management and Ecology*, 297-322.
14. Larinier M., 1983 – Guide pour la conception des dispositifs de franchissement des barrages pour les poissons, *Bulletin Français de la Peche et de la Pisciculture*, 56, 1-39. (in French)
15. Lenhardt M., Jarić I., Kolarević S., Vuković-Gaćić B., Knezević-Vukčević J., Smedereva-Lalić M., Cvijanović G. and Gačić Z., 2016 – Impact of human activities on the status of the Danube River in Serbia: microbiological and ichthyofaunistic studies, *Acta Oecologica Carpatica*, IX, 151-176.

16. McKay S. K., Cooper A. R., Diebel M. W., Elkins D., Oldford G., Roghair C. and Wiefelich D., 2016 – Informing watershed connectivity barrier prioritization decisions: a synthesis, *River Research and Applications*, 33, 6, 847-862.
17. Nechifor R., Popa G.-O., Samu M., Dudu A., Bănăduc D., Costache M. and Georgescu S. E., 2017 – The genetic profiles of two salmonid populations from Romania obtained through nuclear markers analysis, *Animal Science and Biotechnologies*, 50, 1, 74-78, ISSN: 2049-1891.
18. O'Doherty G., 2009 – ADF and G fish passage program: summary of existing inventory and assessment data and gap analysis, September, Special Publication, 10-17.
19. Popa G.-O., Khalaf M., Dudu A., Curtean-Bănăduc A., Bănăduc D., Georgescu S. E. and Costache M., 2013 – Brown trout's populations genetic diversity using mitochondrial markers in relatively similar geographical and ecological conditions – a Carpathian case study, *Transylvanian Review of Systematical and Ecological Research*, 15.2, *The Wetlands Diversity*, Edit. Universităţii "Lucian Blaga" din Sibiu, ISSN 1841-7051, 125-132, 2013.
20. Popa G.-O., Curtean-Bănăduc A., Bănăduc D., Florescu I. E., Burcea A., Dudu A., Georgescu S. E. and Costache M., 2016 – Molecular markers reveal reduced genetic diversity in Romanian populations of Brown Trout, *Salmo trutta* L., 1758 (Salmonidae), *Acta Zoologica Bulgarica*, 68, 3, 399-406, ISSN 0324-0770.
21. Posea G. (coord.), 1982 – Enciclopedia Geografică a României, Edit. Ştiinţifică şi Enciclopedică, Bucureşti, 847. (in Romanian)
22. Sedeño-Díaz J. E. and López-López E., 2009 – Aquatic health assessment: a methodological proposal for Mexican aquatic ecosystems, *Transylvanian Review of Systematical and Ecological Research*, 8, *The Wetlands Diversity*, 201-214.
23. Sommerwerk N., Bloesch J., Paunović M., Baumgartner C., Venohr M., Schneider-Jacoby M., Hein T. and Tockner K., 2010 – Managing the world's most international river: the Danube River basin, *Marine and Freshwater Research*, 61, 7, 736-748, doi.org/10.1071/MF09229.
24. Voicu R. and Merten E., 2014 – Creating a system for upstream-downstream fish migration over the first and the second discharge sills downstream of Mănăştur dam on the Someşul Mic River (Cluj Napoca, Transylvania, Romania), *Transylvanian Review of Systematical and Ecological Research*, 16, 2, *The Wetlands Diversity*, 163-182.
25. Voicu R. and Breţcan P., 2014 – Solution for fish migration on the Someşul Mic River upstream downstream of Mănăştur dam in Cluj Napoca, *Annals of Valahia University of Târgovişte, Geographical Series*, 14, 1, 125-132.
26. Voicu R. and Baki P., 2017 – Improving upstream and downstream fish passage at Retiş dam on Hârţibaciu River – Sibiu County (Transylvania), *Annals of Valahia University of Târgovişte, Geographical Series*, 17, 1, 47-57.
27. Voicu R., Costescu C., Voicu L. and Lengher-Bica N., 2015 – Solution for ichthyofauna migration upstream-downstream of the two spillways located near Mănăştur dam on the Someşul Mic River in the Cluj Napoca City (România), *Lakes, reservoirs and ponds*, 9, 1, 43-55.

**THE HUMAN IMPACT
AND THE AQUATIC BIODIVERSITY
OF LAKE BOSOMTWE:
RENAISSANCE OF THE CULTURAL TRADITIONS
OF ABONO (GHANA)?**

*Dickson ADOM **

* Department of General Art Studies, Kwame Nkrumah University of Science and Technology, Kumasi, Ghana, P.O. BOX NT 1, adomdick@yahoo.com

DOI: 10.1515/trser-2018-0007

KEYWORDS: aquatic biodiversity, lake Bosomtwe, human impacts, cultural traditions.

ABSTRACT

The lake Bosomtwe in the Abono Village in the Ashanti Region of Ghana is in a deplorable state, thereby negatively affecting its rich aquatic biodiversity. The condition is blamed on the negative human impacts on the lake. A phenomenological study of the qualitative approach was undertaken to investigate this phenomenon. The findings revealed that the deteriorating condition of the lake is due to the weak implementation of the cultural traditions of the Abono people. The study proposes the strict observance of the cultural traditions as a complement to the scientific models to avert the want and destruction of the aquatic biodiversity of lake Bosomtwe of Ghana.

RÉSUMÉ: L'impact humain et la biodiversité aquatique du Lac Bosomtwe: renaissance des traditions culturelles d'Abono (Ghana)?

Le Lac Bosomtwe du village d'Abono dans la région d'Ashanti de Ghana se trouve dans un état déplorable, ce qui a un impact négatif sur sa riche biodiversité aquatique. L'état du lac est dû à l'impact humain négatif. Afin d'étudier ce phénomène, une étude phénoménologique d'approche qualitative a été mise en place. Les conclusions ont mises en évidence le fait que l'état de détérioration du lac est dû à la faible mise en oeuvre des traditions culturelles du peuple Abono. L'étude propose le strict respect des traditions culturelles, ainsi que des modèles scientifiques afin d'éviter la destruction aveugle de la biodiversité aquatique du Lac Bosomtwe de Ghana.

REZUMAT: Impactul antropic și biodiversitatea acvatică a Lacului Bosomtwe: renaștere a tradițiilor culturale din Abono (Ghana)?

Lacul Bosomtwe din satul Abono în regiunea Ashanti din Ghana se află într-o stare deplorabilă, ceea ce afectează negativ bogata biodiversitate acvatică. Starea lacului este pusă pe seama impactului antropic negativ. Pentru a cerceta acest fenomen, s-a efectuat un studiu fenomenologic cu abordare calitativă. Concluziile au pus în evidență că deteriorarea stării lacului se datorează slabei implementări a tradițiilor culturale ale populației Abono. Studiul propune respectarea cu strictețe a tradițiilor culturale în plus față de modelele științifice pentru a evita distrugerea prin neglijență a biodiversității acvatice al Lacului Bosomtwe din Ghana.

INTRODUCTION

Aquatic biodiversity is defined as the diversity of plant and animal populations in the aquatic ecosystems such as rivers, lakes, ponds, oceans, bays, marshes and swamps (Helfrich et al., 2009). This diversity of life has been the sole sustaining force for generations (Adom et al., 2017). Bradley et al. (2012) concur the aquatic biodiversity offers humans their basic necessities of life; food, clothing and shelter. In fact, aquatic biodiversity present in all the aquatic ecosystems has a very significant role to support and make life on the planet possible. Helfrich et al. (2009) sums up the benefits including the provision of jobs via the tourism potentials of aquatic ecosystem as ecotourism, buffer against new diseases, ensuring food security and the massive reduction of carbon dioxide to improve the atmospheric condition of the earth. Due to the indispensable roles and relevance of aquatic biodiversity, there is an urgent need to conserve and sustain them. It is sobering, the global estimates of the depletion of the aquatic biodiversity are astronomical (WWF, 2016). Therefore, Adom (2016a, b) noted recently the resurgent interests of both international and national bodies to look for feasible strategies for arresting this deleterious state of aquatic biodiversity that supports life. The sustainability of the aquatic biodiversity is essential to the general well being of the environment and human life because both depend on the aquatic life and their quintessential ecological functions for life survival (Helfrich et al., 2009; Adom et al., 2017).

There are several established factors that have caused the abysmal decline in the aquatic biodiversity globally that threaten the survival of life on Earth (Hogan, 2010; Shah, 2014). Paramount amongst these causative factors is the anthropogenic factors, particularly, the impacts of human activities, labelled as a critical environmental issue (National Research Council, 1995, in Lamptey, 2015; Khoshnood, 2017). This condition was foreseen due to the growing population rate, especially in the Africa sub-region (Harden, 1968). Orighabor (2016) noticed that human activities in various forms ranging from poor agricultural, domestic and industrial activities to the bad disposal of sewage and pollutants are detrimental to the aquatic life and resources in the various aquatic ecosystems.

The state of the aquatic biodiversity in the largest, natural lake in West Africa, lake Bosomtwe, is in a deplorable state due to unbridled and poor management of human activities. These include illegal housing construction (Mohammed, 2014); crop cultivation and deforestation of the vegetation (Adu-Boahen et al., 2015); over fishing, pastoral farming and waste disposal (Abreu et al., 2016). There have been many suggestions put forward to curb the identified human impacts that are negatively affecting the state of aquatic biodiversity in the lake Bosomtwe Basin. For instance, Abreu et al. (2016) suggested the undertaking of modern scientific models in environmental management such as Environmental Impact Assessment (EIA) in every project undertaken at the catchment of the lake, using biological and ecological indicators such as the Macro-benthic invertebrates monitoring programme, physical, chemical and bacteriological assessment and water quality parameters assessment, to arrest the canker of human impacts from destroying the aquatic biodiversity of the lake. Towing the purely scientific conservation strategy, Adu-Boahen et al. (2015) recommended the re-planting of native vegetation to check and arrest soil erosion as well as strict cautioning against the unbridled application of chemical fertilizers in agricultural activities undertaken in the lake Bosomtwe Catchment. Admittedly, these scientific conservation strategies are very effective in controlling the abuse of aquatic biodiversity in any region. However, an over-reliance on only the scientific models in a one lens approach cannot remedy the deleterious state of the abuse of the aquatic biodiversity (Adom et al., 2016a, b) as well as halt the negative human impacts that disturb the sanity of the lake Bosomtwe. There is the need to look for other alternatives to the implementation of the scientific strategies for more pluralistic approaches (Wilder et al., 2016).

Scholars who have undertaken research projects in lake Bosomtwe have realized that the inhabitants in the close to sixty local communities (Abreu et al., 2016a, b) are traditional people (Dassah and Agbo, n.d.) whose worldviews are shaped and regulated largely by cultural traditions (Adom et al., 2016a, b). This is not misplaced because to the local residents around the lake Bosomtwe, believe that the lake, its origin and management, pivots on indigenous theories that are driven by cultural traditions such as religious beliefs, taboos, totemic system and norms. In such an environment where culture reigns high in monitoring the behavioural attitudes of residents, it would be very beneficial to look into the cultural traditions that regulated the attitudes of local residents around the lake Bosomtwe catchment, savouring the abuse of its rich taxas of aquatic biodiversity. This is keen because “the cultural traditions have a great affinity with environmental protection” (Adom, 2017). Researchers have realized that disregard for the customs, beliefs and norms (cultural traditions) that effectively monitored and curtailed all forms of negative human impacts by both the local residents and visitors who tour the site is the sole cause of the lake’s sorry state (Mohammed, 2014; Lamptey, 2015; Adu-Boahen et al., 2015). This condition, which has caused the weakening of cultural traditions in strictly monitoring the activities of the people, raises many questions such as: what caused the relaxed implementation of the cultural traditions? How effective were these cultural traditions in protecting the aquatic biodiversity in the lake Bosomtwe in the past? Can there be a renaissance of those cultural traditions in the face of modernisation? How can these cultural traditions be harnessed to serve as an effective traditional strategy, as a synergy to the purely scientific models to salvage the deplorable state of the aquatic biodiversity in lake Bosomtwe?

Furnishing answers to these important questions would help in arresting the negative human impacts on the aquatic biodiversity while helping in redeeming its past glory. This research is informed by an early research in assessing the impacts of Asante indigenous knowledge in the local communities in the Asante Bekwai District, Ashanti Region of Ghana which falls within the catchment of the lake Bosomtwe (Adom, 2016a, b). The study revealed that cultural traditions still hold high currencies in the worldviews of the people and can be a viable tool in regulating their activities that are not favouring the lake. Therefore, a thorough and extensive study into these cultural traditions for new strategies to help regulate the human activities for especially the aquatic biodiversity (Anim et al., 2013) is needed. It is this academic gap in the various research projects that have been carried out in the lake Bosomtwe that is to be filled by the study. The study is driven by four main objectives:

1. To investigate into the human impacts on the aquatic biodiversity of lake Bosomtwe in Ghana;
2. To find out the influence of the cultural traditions of Abono on human activities that affects the aquatic biodiversity of lake Bosomtwe;
3. To suggest how the effective cultural traditions can be harnessed as a strategy to complement the scientific models to improve the state of the aquatic biodiversity of lake Bosomtwe.

Precise information of this would truly inform the environment related institutions and interested people on how they can use the cultural traditions of the people in arresting the negative human impacts on the aquatic biodiversity of lake Bosomtwe. We suspect it would improve the aquatic biodiversity of the lake; increase its eco-tourism, boost the environmental health and atmospheric conditions of the lake basin while improving on the quality of life of the people through improved economy.

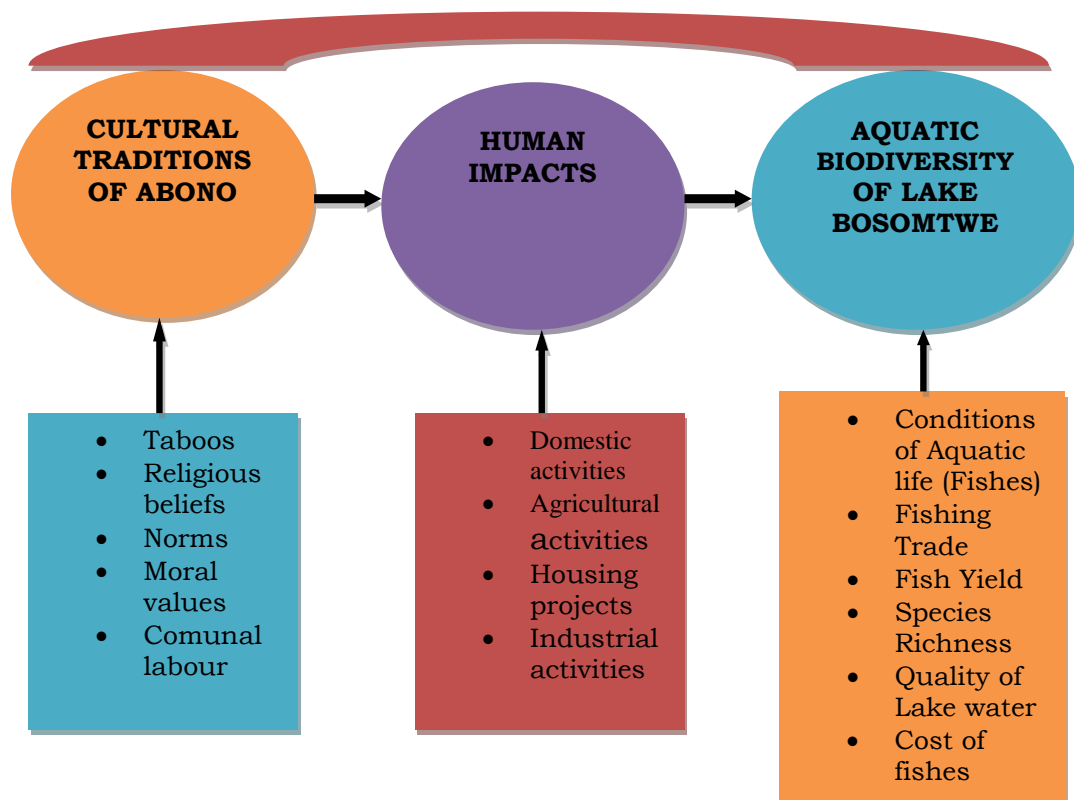

Figure 1: Conceptual framework for the study; researcher's construct from the field survey, 2017.

MATERIAL AND METHODS

The research was rooted in a cultural anthropology study at Abono (60 32'01.50"N; 10 25'44.53"W), the most populous and populated local community (Otu, 2010) amongst the sixty local communities around the lake Bosomtwe catchment in the Ashanti Region of Ghana. The study was undertaken over a ten month period from September 2016 to June 2017 to ascertain the impacts of human activities on the aquatic biodiversity of the lake and investigate into how the cultural traditions of Abono could be used as a strategy in curbing the negative activities of residents and visitors.

Due to the cultural and social context that characterizes the study, the qualitative study approach was utilized (Denzin and Lincoln, 1994). Two principal data collecting instruments in anthropology namely interviews (Personal and Focus Group Discussion) and observations (Direct) were used in soliciting for data on the state of the lake Bosomtwe as well as assessing the impacts of human activities and cultural traditions of the people of Abono on the aquatic biodiversity of the lake. The phenomenology research method was used by the researcher in

seeking diverse views and thick description of the phenomenon under study (Leedy and Ormrod, 2010). A total of seven private interviews and twelve Focus Group Discussion interviews were conducted with a sample of sixty-five informants some of whom were purposively sampled while others were randomly sampled. The selection was made from a target population consisting of traditional authorities (Chiefs, Elders in the traditional council, traditional priest), fishermen, conservationists and residents of Abono (Tab. 1; Fig. 1).

Due to the particular characteristics of some of the traditional cultural elements like the revealing the sources of human impacts may not be told in public (Fraenkel et al., 2012), personal interviews were held for the head of the Bosomtwe Forest Reserve, the traditional priest, two leaders of the fishermen and two elderly respondents who are very knowledgeable in the cultural traditions surrounding the formation of the lake Bosomtwe.

The Focus Group Discussions aided in dissuading any pre-conceived and negative ideas about the intent of the research (Pope et al., 2000; Fraenkel et al., 2012) amongst the large rural populace while generating rich opinions from the fruitful discussions (Leedy and Ormrod, 2010). Direct observations for first hand information (Kumekpor, 2002) on the human impacts and their adverse effects on the aquatic biodiversity of the Bosomtwe Lake as well as the cultural traditions were made using a well designed observation checklist.

The purposive sampling was used for the selection of the traditional authorities, elders in the traditional council, elderly respondents above the age of 40, conservationists and fishermen. It was seen as the best sampling technique for selecting this section of the sample who were seen as possessing the unique features of the study objectives and very capable of offering the required data for the study. On the other hand, the youth respondents were randomly selected due to their high numbers and possession of somehow equal knowledge regarding the phenomenon under investigation. (Lewis and Sheppard, 2006; Leedy and Ormrod, 2010)

The Interpretative Phenomenological Analysis (IPA) was used for analyzing the rich data on the phenomena studied from the respondents. Thick quotations from the responses of informants were used in constructing the meanings of the data generated (Fade, 2004; Smith and Osborn, 2008; Pietkiewicz and Smith, 2014). Also, the conservation value of the cultural traditions as potent enough in curtailing the wanton abuse of the aquatic biodiversity in the Bosomtwe Lake was assessed using the model of Smith and Wishnie (2000). The keys in the model are assessing how the cultural traditions ensured:

1. The harvesting restraints of the fishes;
2. The protection of the resource species;
3. The regulation of the onset/duration of harvests;
4. The avoidance of harmful habitat modification;
5. The patch-switching to maximize overall return.

Table 1: Breakdown of interviewees; researcher's construct from the field survey, 2017 (Fig. 1).

No.	Category of interviewee	Total no. selected	Details
1.	Traditional authorities	4	The paramount chief of Abono and his three sub-chiefs were interviewed individually (personal interview).
2.	Elders in the Traditional Council	8	Eight elders that formed the traditional cabinet of Abono were interviewed in a two Focus Group Discussion interview sessions.
3.	Religious officials	1	One traditional priest who performs the periodic rituals in the Bosomtwe Lake was interviewed privately.
4.	Fishermen	12	Two leaders of the fishermen were interviewed privately while the other ten including fish sellers were interviewed in two Focus Group Discussion interview sessions.
5.	Conservationists	6	The head of the Bosomtwe Forest Reserve was privately interviewed while the other five conservationists were interviewed in a Focus Group Discussion.
6.	Elderly residents (40 and above)	34	Two elderly respondents were interviewed privately while 16 elderly respondents were categorized into four Focus Groups consisting of four elders in each were interviewed.
7.	Youth residents (20 years – 39 years)	16	Sixteen youth were randomly selected and interviewed in three Focus Group Discussions.

DESCRIPTION OF THE PROJECT AREA

The research project was carried out at lake Bosomtwe and the Abono community close to the lake. The lake is the only natural inland freshwater lake in Ghana (Adu-Boahen et al., 2015) and the largest natural lake in West Africa (Abreu et al., 2016). Precisely in location, the Bosomtwe Lake is located about 30-35 km South-East of Kumasi, the capital of the Ashanti region at the very centre of Ghana (Asamoah et al., 2015). Almost 60 communities surround the lake with 24 being the main local communities with the other being small villages and towns. However, the populous and largest local community which is the easiest point to enter the lake premises from Kumasi is Abono (Dassah and Agbo, n.d.), where the study was carried out (Fig. 2). It has an estimated population of close to 1,500. There are four major seasons in the lake catchment; the early rainy season (May to July), the monsoon drought (July to August), the late rainy season (September to November) and the dry season (December to April). The temperature around the lake vicinity is usually high at an average of 26°C and about 30°C between the months of March and April (Adu-Boahen et al., 2015) with the annual rainfall falling within the range of 1,500 mm and 1,800 mm. Two types of soil are peculiar to the area. Gleyic Alisols covers approximately 55% of the land mass from the North to the North-Western parts while the South to the South-Eastern parts which is estimated at 45% is of the Ferric Acrisols soil (Abreu et al., 2016). Otu (2010) estimates the minimum height of the rim of the crater as 110 m above current water level which amounts to 99 m a.s.l.



Figure 2: Map of Abono and the location of lake Bosomtwe (<http://www.africaguide.com>).

The formation of the Bosomtwe Lake has two different perspectives. Scientifically, the lake is asserted to have been formed as a result of a meteorite impact forming the crater at the centre of a dense rain forest (Jones et al., 1981). Moon and Mason (1965) confirmed that this resulted in a volcanic eruption creating the dent which was gradually filled with water. That is the etymology of the name of the lake in the Asante language, Bosom (Deity), Twe (Antelope) meaning the lake is for the Deity (Bosomtwe). This probably explains the huge cultural traditions that monitored the management of the lake and the great impact of cultural traditions regarding the lake on the worldview of the local residents living in the surrounding local communities.

The aquatic biodiversity in the Bosomtwe Lake is rich in species, especially freshwater fishes (Tab. 2) with global recognition (Abreu, et al., 2016). When the lake was not wantonly abused, nine genera of fishes belonging to five families and eleven species of fish were recorded (Whyte, 1975). These included the *Barbus ablabe*, *Barbus trispilos*, *Roloffia petersii*, *Epiplatys chaperi*, *Amphilius ateseunsis*, *Heterobranchus isopterus*, *Chromi-dotilapia guntheri*, *Tilapia discolor* (Kaenbre), *Tilapia busumana* (Paripari), *Sarotherodon multifasciatus* (Apatre fufuo) and *Hemichromis fasciatus* (Komfo). Abreu et al. (2016) noted in a recent study that *Tilapia busumana* is currently the only recorded endemic fish species in the lake. Tilapia fish, catfish and mud fish are the common fishes in the Bosomtwe Lake (Asamoah et al., 2015) while the jewel fish is rare.

Table 2: List of freshwater fishes in the lake Bosomtwe; author's construct adapted from List of Freshwater Fishes for Ghana from fish.mongabay.com/data/Ghana.htm

Order	Family	Species	Status
Perciformes	Cichilae	<i>Tilapia discolor</i>	Native
Perciformes	Cichilae	<i>Tilapia zilli</i>	Native
Perciformes	Cichilae	<i>Chrpmidotilapia geunteri geunteri</i>	Native
Perciformes	Cichilae	<i>Sarotherodon galilaeus multifasciatus</i>	Native
Perciformes	Cichilae	<i>Hemichromis fasciatus</i>	Native
Cyprinodontiformes	Nothobranchiidae	<i>Epiplatys chaperi</i>	Native
Cypriniformes	Cyprinidae	<i>Barbus ablabes</i>	Native
Cypriniformes	Cyprinidae	<i>Barbus trispilos</i>	Native
Siluriformes	Claridae	<i>Heterobranchus isopterus</i>	Native
Siluriformes	Amphiliidae	<i>Amphilius atesuensis</i>	Native
Siluriformes	Claridae	<i>Heterobranchus bidorsalis</i>	Native

Interestingly, traditional equipments and tools are used for the main artisanal fishing activities. Wooden boat-like devices measuring about 18 feet are used as fishing crafts referred to by the fishermen as Padua, is used for fishing while small boxlike pieces of plywood are used for paddling. Three main fishing gears are used by the fishermen (Figs. 3-8). These are the wire mesh traps (Ensoa), the gill nets (Twee) (25 m × 2 m – 3 m) and cast nets (Twee Kese) (one m – two m) (Dassah and Agbo, n.d.). There are currently no indices to measure the yield of fish caught. However, it is estimated that 27 tons of fish are harvested in a day while about 2,720 kg are harvested every four hours (Dassah and Agbo, n.d.). These estimated figures are not constant and may dwindle considerably in varying seasons and the fishing pressure on the lake at any given fishing day. Rattan and palm frond woven containers are used as receptacles for keeping the harvested fishes before fish sellers come to purchase at the shores of the lake.



Figure 3: Wire Mesh Traps.



Figure 4: Cast Nets.



Figure 5: Wooden fishing craft (Padua).



Figure 6: A fisherman with a container.



Figure 7: Author interviewing one of the leader of the fishermen in Abono.



Figure 8: Gill nets used for fishing.

RESULTS AND DISCUSSION

The findings and discussions of the research are discussed under three main headings, namely: the state of the aquatic biodiversity of Bosomtwe Lake, the human impacts on the aquatic biodiversity, and the cultural traditions of Abono and its impact on the use of aquatic biodiversity.

The state of the aquatic biodiversity of lake Bosomtwe Species richness

Lake Bosomtwe is a storehouse of a great variety of aquatic species. In terms of fisheries, there are currently four principal species out of the eleven species that were discovered by Whyte in 1975 that are common in the fishes that are caught by the fishermen. These are *Tilapia discolor* (Kaenbre), *Tilapia busumana* (Paripari), *Sarotherodon galilaeus multifasciatus* (Apatre fufuo), and *Hemichromos fasciatus* (Komfo). The other species are rare and fishermen chance on them, especially the species *Roloffia petersii*, and *Epiplatys chaperi* during the high peaks of rain during the months of June and July every year. The current state of species richness is very low as lamented by the leaders of the fishermen. In a personal interview, one of them informed the researcher that: “when I was ten years old, I used to go for fishing with my father who was the chief fisherman in Abono at that time. There were different kinds (species) of fishes of different nature, colours and so forth. It is distressing that today only three or four kinds (species) of fishes are captured by me and the other fishermen. I fear that all the fish species in our lake are dying out” (FL, Personal communication, 17 November, 2016).

Similar sentiments were expressed by the other fishermen and residents in the area. The chief women fish sellers in Abono who are now over eighty-five years disclosed to the researcher: “there were great varieties in the fishes that I used to buy from the fishermen when I was in my youthful exuberance. *Tilapia discolor* (Kaenbre), *Tilapia busumana* (Paripari), *Sarotherodon galilaeus multifasciatus* (Apatre fufuo) and *Hemichromos fasciatus* (Komfo) were very common. Today, the fishermen can’t get many of them. It is only Apatre fufuo and Kaenbre that we sell” (FS, Personal Communication, 19 November, 2016).

The researcher and his assistants observed this situation in fifteen days direct observations of the species of fish that were captured by the fishermen. Many of the former species recorded are no more, probably endemic. Only few fish species mentioned earlier were recorded. This affirms the assertion made by Dassah and Agbo (n.d.) that roughly four species of fish, namely *Tilapia busumana*, *Tilapia discolor*, *S. galilaeus multifasciatus* and *H. fasciatus*.

Fish sizes and fish yield

All the respondents interviewed admitted that the sizes of the fishes as well as their yields have greatly dwindled. The largest size of the fish caught measured 25 cm length × 14.8 cm wide, the medium size measured 16 cm length × 7.4 cm wide while the small fishes measured eight cm length × 3.9 cm wide. The fish yield, which used to be 27 tons of fish in a day, has reduced drastically to few tons of six to eight tons a day. Lamenting on the dwindling sizes and yield of fish, the fishermen in a focus group discussion said: “we used to fish about 40 big catches of fishes, but now we get less than 25 smaller-sized fishes in a 12 hour fishing expedition. They are greatly small in size that is why some of us are using very small meshed nets. If you do not use it, you will go home hungry and you would not get anything to cater for your family” (FFFS-FGD, Personal Communication, 25 November, 2016).

The sizes of fishes and the sizes of the mesh of the nets that were used were below the allowed minimum size of 60 mm in the Fisheries Regulations (Fisheries Regulations of Ghana, 2010). Likewise, the small fishes below the length of 14 cm (Fig. 9) banned by the Fisheries Ministry were caught by the fishermen because of poverty and the great need to survive.



Figure 9: Small fishes measuring below eight cm caught by the fishermen at Abono.

This disturbing situation is as a result of over-fishing at the lake Bosomtwe. There are no well regulated closed season observed and fishermen constantly engaged in fishing without any strict monitoring system on the harvesting of fishes. This observation made by the researcher confirms what was said by Lamptey (2015) and Nketia et al. (2016) that there is a high rate of overfishing at the Bosomtwe Lake basin, attributing it to the rising population levels that largely depend on the fisheries as sources of livelihood and their impoverished state which were the other identified factors causing the reduction in fish yield. Excessive, unrestrained pressures on the fishes do not allow them adequate time to grow into bigger sizes.

Another recognised factor is the mass destruction of the feeding sites of the young fishes leading to malnutrition affecting their growth pattern and the massive decline of many of the young fish due to lack of food. The phytoplankton that are to be abundant to feed the zooplankton as well as the aquatic macrophytes, benthos, allochthonous fauna and other plant debris have been destroyed by the high levels of phosphorous and nitrate from fertilizers leached from the farmlands in the lake catchment. The destruction is also caused by the huge downpour of domestic sewage, industrial effluents, and soda detergents into the lake from households and guest houses surrounding the lake. As Orighabor (2016) cautioned, if stringent measures are not put in place to arrest these negative human impacts, the aquatic life of all aquatic ecosystems may be destroyed entirely. These situations have been realized at the lake Bosomtwe Catchment and are the causes of the reduction in fish sizes and fish yield. This may be the reason why Abreu et al. (2016) suggested the provision of alternative sources of livelihood for the local residents to ease the pressure on overfishing.

Fish cost and fish trade

The reduced sizes of fishes (Fig. 10) and yield have impacted greatly the cost of fish and the fishing trading in general. The fishermen informed the researcher that due to the poor revenue they get from the few fish they catch, they can't effectively take care of their families. This has resulted in a large number of children dropping their education and following their parents for fishing. This was equally realised by Adom et al. (2016a, b). Children in their teens mentioned that their parents could not pay their school fees (four dollars), purchase them school uniforms (two dollars) or buy them textbooks (three dollars). Many of the residents in the Abono community have left to urban centres for greener pastures. Generally, this has reduced the close to sixty communities to twenty two communities currently. The prices of fish are high and the poor rural residents cannot afford them. Therefore, the fish sellers take the few fish they have and try to sell them in the more populous communities. They lamented that the cost of transportation also exerts great toll on their profits. Some of the fish sellers interviewed in a Focus Group Discussion told the researcher that: "we used to buy the fishes at relatively lower costs from the fishermen which we sell for some reasonable profit, but now, they have increased the prices due to the scarcity of the fishes in the Bosomtwe Lake; we used to earn about sixty-five Ghana Cedis (seventeen dollars) a day, but now many of us earn only twenty-five Ghana Cedis (seven dollars); making ends meet is really difficult; many of our colleagues have moved to different areas and entered into other professions because the fishing trade is no more lucrative" (FFG-FGD, Personal Communication, 24 November, 2016).



Figure 10: Small fishes fried for sale.

The truism of the findings is supported by the observations made by Adu-Boahen et al. (2015) who mentioned of the massive rural-urban migration affecting the communities surrounding the Bosomtwe Lake due to the lower income levels generated from the fishing.

Quality of water of the lake Bosomtwe

Some years ago, due to the serenity of the Bosomtwe Lake, it was used as the main source of drinking water for the Abono community and the other communities surrounding the lake, as disclosed by some of the elders in the traditional council of Abono to the researcher. Unfortunately, the lake water is no more drinkable due to the negative human impacts (Figs. 11 and 12). The direct washing and bathing in the lake with soda soaps have increased the concentration of nitrates and phosphates, marring the quality of the lake water. The direct discharges of domestic sewage and industrial effluents as well as leaching of chemical fertilizers have increased the level of eutrophication, making the water not potable for drinking. The poor local people have to purchase treated water in rubbers and bottles. The poor who can't afford, drink it and are affected by waterborne diseases like amoebic dysentery and Giardiasis (Adom et al., 2016a, b). Sadly, some visitors who engaged in swimming in the Bosomtwe Lake also complained of skin rashes and this may be as a result of the infiltration of the lake by pollutants from the negative human activities, this may be due to the acidity of the Bosomtwe Lake, below pH 7.0 (Gorde and Jadhav, 2013).



Figure 11: Washing of clothes on the shores of the Bosomtwe Lake



Figure 12: Domestic effluents in Bosomtwe Lake.

The human impacts on the aquatic biodiversity of lake Bosomtwe

The human impacts noticed at the Bosomtwe Lake has been categorised into four main groups: domestic activities, agricultural activities, housing and infrastructure activities and industrial activities (Tab. 3). The respondents expressed great concern about how the weak regulation and monitoring of the activities of residents and visitors to the lake has resulted in gross environmental malfeasance. Some of the elderly respondents, in a focus group discussion disclosed some of the negative actions by some farmers whose farms are on the shores of the lake: "the crop farmers wash their farming implements, containers for their chemical sprayers and pesticides directly into the lake. The Pastoralists also leave their cows, sheep and goats unattended and they wander around the shores of the lake defecating there while grazing the forest vegetation that provides a buffer for the lake" (EER-FGD, Personal Communication, 22 November, 2016).

These chemical substances introduce high levels of nitrate and phosphates into the lake increasing the mortality rate of fishes due to the destruction of plankton that serves as food for them (Orighabor, 2016). The gradual degradation of the forest vegetation also exposes the lake to soil erosion and high evaporation which destroys the quality of the lake water (Nketia et al., 2016).

The researcher observed the high rate of bush burning from the slash and burn practices of farmers and the burning as well as clearing of forest vegetation in hunting activities for wild animals like grass cutters. This is destructive to the aquatic biodiversity of the Bosomtwe Lake. Anim et al. (2013) reveals that these practices result in atmospheric deposition of high levels of sulphate and nitrate that increases the salination and the acidity of the water. This contamination of the water makes its consumption by the aquatic species very harmful. This explains the reduction in the fish sizes and yield lamented by the residents.

The washing of cars of tourists by the teenagers at the shores of the lake Bosomtwe transfers pollutants directly into the basin. The women wash their clothes, utensils and other household items in lake while throwing residues of leftover foods into the lake. It was observed that residents troop to the lake catchment early morning to bath in the lake using local soaps called *Amonkye*, *Alata samina*, *Azuma twede* which contain high levels of soda (phosphate) deposited in the lake. Others without shame engage in open defecation at the shores of the lake, while others ease themselves in plastics and throw them into the lake at early hours of the day. These practices increase the contamination of the lake. Nketia et al. (2016) concur that such practices reduce the environmental health of aquatic biodiversity.

Table 3: The human impacts on the aquatic biodiversity of lake Bosomtwe; author's construct from the field survey, 2017.

Negative Human Activities	Associated Impacts on Aquatic Biodiversity
<p>Domestic Activities</p> <ul style="list-style-type: none"> ✓ Washing of clothes and cars ✓ Bathing in the lake ✓ Throwing of refuse at the shores of the lake ✓ Domestic effluents (food residues) ✓ Open defecation (human and animal) ✓ Littering at the shores 	<ul style="list-style-type: none"> ❖ High aggregates of nitrate and phosphate result in the reduction in plankton that support the lives of fishes ❖ High level of eutrophication from leaching from farmlands into the lake killing fishes ❖ The reduction of oxygen in the lake making life unfavourable for the fishes who must compete for oxygen with biodegradable pollutants from domestic effluents ❖ Slow strangulation of fishes, amoebic dysentery and giardiasis ❖ Water poisoning and acidity destroying aquatic life

	<ul style="list-style-type: none"> ❖ Crop cultivation at the hillsides of the lake results in soil erosion, siltation and massive deposition of debris of rocky substances in the lake threatening the habitats of benthic invertebrates and the feeding sites of fishes
<p>Agricultural Activities</p> <ul style="list-style-type: none"> ✓ Fishing ✓ Crop farming (deforestation) ✓ Livestock/pastoral farming ✓ Hunting 	<ul style="list-style-type: none"> ❖ Destruction of the vegetation cover results in high levels of evaporation, reducing the volumes of water and the habitats of the aquatic life ❖ Chemical fertilizers, insecticides and pesticides sprayed on crops in farmlands near the Bosomtwe Lake increases eutropication and destruction of feeding sites of fishes ❖ Livestock allowed to graze in the vegetation bank of the lake is causing soil erosion at the shores, increasing the evaporation of the lake. The excreta from the livestock are washed into the lake, and this contributes to the exacerbation of nitrate and the destruction of aquatic lives ❖ Hunting of wild animals results in bush burning increases the pollution of the atmosphere and high deposition of sulphuric and nitrate compounds into the atmosphere that results in the acidity of the lake when there is heavy rainfall
<p>Housing/infrastructure projects</p> <ul style="list-style-type: none"> ✓ Construction of New Guest Houses ✓ Construction of Roads 	<ul style="list-style-type: none"> ❖ Disrupts the paths of waterways, estuaries and tributaries of the lake, resulting in the reduction of the water volumes of the lake ❖ Change of the ecosystems of aquatic species, forcing migrations and

	<p>eventual loss and/or extinction of particular species of fish</p> <ul style="list-style-type: none"> ❖ Reduction in the water quality as well as the species richness of macro-benthic invertebrates
<p>Industrial Activities</p> <ul style="list-style-type: none"> ✓ Plastic waste disposal ✓ Waste water and sewage disposal ✓ Mining and other exploration activities 	<ul style="list-style-type: none"> ❖ Industrial waste disposed into the lake reduces the species richness and population of the fishes while marring the potability of the lake water ❖ Introduction of heavy metals and organochlorines into the lake through mining operations, threatening the life sustainability of aquatic species ❖ Chemical agents like Cyanide for mining close to the shores of the lake leach into the lake during heavy rainfall, contaminating both surface and ground water, increasing its acidic level, making its consumption by fishes lethal

The elderly respondents registered their displeasure at the selling of plots of land closer to the shores of the lake to the infrastructure developers by the traditional council of Abono. These have been used for the construction of guest houses to accommodate visitors at the site for business purposes. However, the poor waste management systems that these construction sites have as well as the eroding of the forest bank, deepens the woes of the aquatic biodiversity of the lake. Some of the lands have been sold to industries and mining firms for operation. As a result, they have constructed roads that distract waterways of the lake. The high soil erosion and the eventual settling of rock sediments into the lake results in habitat destruction, water contamination (Anim et al., 2013), heavy metal deposition, eutrophication and other hazards to the aquatic lives (Mohammed, 2014; Orighabor, 2016). The chiefs and the members of the traditional council of Abono could not provide any tangible reasons for selling the catchment areas of the lake as plots of lands to these industrialists and infrastructure developers. They defended themselves that they did that for developmental reasons. They claimed that it created job avenues for the youth in their community. However, this action, to the researcher, was triggered by selfish interests since many of the employees at those sites were from urban centres. Also, in no way should those plots of land have been given to the developers because they are stepped directly on the thresholds of the lake. Its consequences have rather exacerbated the unemployment rates in the community and more importantly the aquatic biodiversity of the lake.

Cultural traditions of Abono and the aquatic biodiversity of lake Bosomtwe

The views of the local residents on the causes of the sorry state of the lake revealed that it was as a result of the relaxed implementation of the cultural traditions of Abono. Many of them believed that the sheer breach of these cultural traditions that served as traditional monitoring systems of the negative human activities on the lake has angered the lake deity (Bosomtwe). Thus, they believed it was the deity who has withheld the bountiful supply of fishes as punishment for disregarding his sacred statutes. The elderly respondents and the residents unanimously admitted: "the owner of the lake, Bosomtwe deity, has been slapped by the actions of our people. The mandatory ceremonial sacrifices of cows, sheep and dogs to him have not been carried out for years by the Asamanhene (Chief of Asaman, A local community around the lake), who is traditionally obliged to do so. In addition, some of the indigenes and, especially, the tourists to our lake flout the precepts, taboos and norms that the deity requires that they are observed. Owing to this, he has also decided to keep his fishes to punish us" (FFE-FGD, Personal Communication, 24 December, 2016).

The breach and failure to observe the cultural traditions are largely blamed on the relaxed attitudes of the Management Council of the lake Bosomtwe as well as chiefs and their traditional council's inability to enforce the cultural traditions. The residents interviewed stated that because of the greediness and irresponsibleness of the Management Council and Traditional Council, they take exorbitant monies from tourists and developers and looks unconcerned at the woes they cause the lake deity when his sacred statutes are infringed. They have sold portions of land closer to the shores which, traditionally, they were not supposed to do. They have folded their arms, watching while the sacredness of the deity and his lake are defiled due to their personal interests. They told the researcher: "both the Management Council of the lake and the Traditional Council are insensitive to the deplorable state of the lake. Many of the former cultural traditions that were held in high esteem by our ancestors are no more effective. Because they (Management Council and Traditional Council) have taken monies to fill their own pockets, they allow the developers and tourists to engage in all forms of environmental malfeasance which are tabooed" (FFE-FGD, Personal Communication, 4 January, 2017).

Probing further, the researcher mentioned the specific cultural traditions that have been breached due to the poor surveillance of the chiefs, Traditional Council and Management Council of the Lake. The feedbacks have been provided in table 4.

Table 4: The Cultural Traditions of Abono and Conservation of Aquatic Biodiversity; field survey, 2016.

Cultural Tradition	Activities/Actions Required	Conservation of Aquatic Biodiversity by the Standards of Smith and Wishnie (2000)
Taboos	<ol style="list-style-type: none"> 1. The forest vegetation and its surrounding lands around the lake are not supposed to be encroached. 2. No bathing, washing and dumping of any foreign substance in or around the shores is allowed. 3. Having sexual intercourse in or around the lake is prohibited. 4. Women and young girls in their menstrual cycle are not supposed to go near the lake for any activity whatsoever. 5. No black container (cooking utensils) is supposed to be sent to the lake. 6. No fishing is supposed to be carried out on taboo days (Tuesdays and Sundays). 7. December to April is a closed season and mass fishing is prohibited. 	<ol style="list-style-type: none"> 1. The taboo days and closed seasons restrain harvesting activities and regulate the duration of the harvesting of fishes. It aids in ensuring that the fishes get adequate time to procreate and maximize their numbers and diversities. Also, it prevents overfishing, which is a major problem with the Bosomtwe Lake. 2. The maintenance of forest vegetation around the buffer zones of the lake as well as construction activities on the shores of the lake also helps in preventing all forms habitat modifications. This would help in avoiding the destruction of the feeding sites (plankton) of the fishes. 3. The taboos largely ensure the protection of the aquatic species. Pollutants and other environmentally unfriendly activities banned due to the taboos would assist in protecting the rich diversities of fishes and other forms of aquatic life in the lake.
Religious beliefs	<ol style="list-style-type: none"> 1. Blocking the water ways of the lake would incur the wrath of the lake deity. 2. Felling trees and clearing of the forest vegetation would bring death to one's lineage. 3. Sacrifices (regular and periodic) must be performed for the lake deity. 4. Everyone would account to 	<ol style="list-style-type: none"> 1. The religious beliefs imposed the fear of not incurring the anger of the deity by engaging in any form of environmentally deleterious actions. The periodic sacrifices renew the sacredness of the lake and all its aquatic life. Thus, in no way would residents engage

	the ancestors after their physical passing, how they behave towards the resources in their environment.	in constructional activities that would modify the habitats of the lake, its estuaries and aquatic biodiversity. 2. The imposition of accountability after the death of society members places a responsibility for each member of the community, not to engage in any human activity that would destroy the biodiversity species in the lake and its environs.
Norms	1. The words of the elders in the community must be respected and honoured. 2. The statutes of the chiefs and Traditional Council must be observed without any recourse to objections and arguments.	The respect for the elderly that would be heightened would impact on how the younger generation heed to the norms set by the traditional and management councils on not engaging in any activities that would destroy the aquatic biodiversity (their habitats, mitigate their populations and diversities).
Moral Values	1. The youth must respect the elderly. 2. Every resident must desist from greed and any action that is triggered by selfish interests and desires. 3. The future generation must always be thought of when engaging in any action against the environment. 4. Humans are stewards of the environment and would account to the higher spirits and ancestors after their physical death.	Propagating the ideals of selflessness and a thought about the future generation would cultivate in the younger generation, the need to respect the closed seasons while conserving the lake in its pristine form for the unborn generations. This would prevent overfishing and all forms of habitat destruction.
Communal Labour	1. The lake deity and ancestors require that the entire society is clean and its	The protection of the species of aquatic biodiversity and the prevention of habitat

	<p>environment is healthy.</p> <p>2. Participation in communal labour is mandatory and failure will be spiritual repercussions from the deity and ancestors while monetary sanctions and sacrifices would be required by the Traditional Council.</p>	<p>destruction is enhanced through the communal labour sessions. The local people remove all forms of debris and pollutants at the shores of the lake that would have ended up causing eutrophication, maximization of phosphate and nitrate levels and so forth.</p> <p>It would cultivate the ideals of conservation and sustainability in residents.</p>
--	---	---

The people strongly believe that if the cultural traditions are heightened, it would reverse the deplorable state of the lake and assist it to earn its past glory or image. This would call for attitudinal change on the part of the governing class, the local residents and visitors who tour the lake. This is true because the local youth told the researcher that they have refrained from engaging in communal labours, especially at the lake premises because the Traditional Council and the Management Council selfishness take all the proceeds from the site. They do not see the use of the funds profitably to benefit them and the entire community. They lamented that when they are engaged as tourist guides by the Councils, they fail to pay them their due. Thus, they also retaliate by usurping their orders and statutes. This affirms Adom (2016b) assertion that when local people are actively involved in societal issues, they tend to support the activities wholeheartedly. Knowing that they are the cause, the hands of the Councils are tied in punishing the infringers of the cultural traditions. When the researcher questioned the Management Council and the Traditional Council regarding why the cultural traditions are in a relaxed manner, they rather blamed it on the incapacitation of the Asantehene (The king of the sovereign Asante Kingdom) to give proper directives for the full implementation of the cultural traditions of the site. Others also put the blame the influx of Christianity and modernization as asserted by Adom (2016a). Surprisingly, the chief of Abono who is no more staying in the town is accused by the people as not caring for their plight and the condition of the lake. They mentioned that he is wealthy and as such hardly step his foot in the town and whenever he does, it is because he is coming for the revenue from the proceeds of the lake which he has disregarded and left unprotected.

Thus, the findings from the study indicates that the stringent implementation of the cultural traditions of Abono is seen as a potential strategy to salvage the deleterious condition prevalent at the Bosomtwe Lake as asserted by Abreu et al. (2016). Interestingly, these cultural traditions have underpinnings of the scientific methods and have great conservation ethos as Adom (2017) equally noted in his study of the cultural traditions of Anyinam. Therefore, if firm structures are put in place to implement the cultural traditions aside from the scientific strategies it would aid in saving the lake and curtailing all forms of negative human impacts on the aquatic biodiversity of the Bosomtwe Lake.

CONCLUSIONS

The study has unearthed the state of the aquatic biodiversity in the Bosomtwe Lake. It has shown that currently, the diversities of the species in the aquatic biodiversity is fast depleting and immediate strategies must be devised to avert the abuse. The human impacts were largely seen in the negative activities of residents and visitors in domestic, industrial, construction, mining and agricultural activities. It is realised from the study that the cultural traditions of Abono have strong conservation ethics for the aquatic biodiversity as have been shown via the assessment using the parameters set by Smith and Wishnie (2000). The relaxed state of the cultural traditions due to the inefficiency in the discharge of the monitoring duties of the chiefs, the Traditional Council and the Management Council of the Lake is a paramount cause of the negative human activities that is destroying the aquatic biodiversity. Also, the lack of support from the local residents and the ignorance of the visitors regarding the cultural traditions have also contributed to the wanton destruction of the aquatic biodiversity of the Bosomtwe Lake. As a result, these recommendations have been forwarded to concerned individuals, groups, agencies and ministries responsible for the upkeep and maintenance of the Bosomtwe Lake and its rich aquatic biodiversity resources:

1. The Ministry of Fisheries and Aquaculture must task the Management Council of the Bosomtwe Lake must increase their monitoring systems and strategies since the lake is part of the aquatic biodiversity heritage of Ghana.

2. The Asantehene (King of the Asante Kingdom) and his cabinet of elders must ensure that the chiefs of Abono, their Traditional Council and the surrounding communities strengthen their governance systems, while enforcing the full implementation of all the cultural traditions of the lake to assist in the preservation of the aquatic biodiversity.

3. The Asantehene must promptly settle all forms of stool disputes to enable the enstoolment of the Asamanhene (Chief of Asaman) who is legally mandated to perform the rituals and ceremonies in connection with the Bosomtwe Lake. This would increase the sacred nature of the lake and psyche the local residents as well as visitors not to defile the lake through the engagement in unhealthy environmental activities.

4. A brochure containing all the cultural traditions that must be observed at the Bosomtwe Lake must be printed and copies distributed to all visitors who tour the site. In addition, orientation sessions must be organized for the visitors and tourists at the site where the cultural traditions are vividly explained with their associated spiritual, sacrificial and monetary penalties. This would mitigate the sheer misconduct at the site on the part of the visitors who in most cases are ignorant of the cultural traditions.

5. The Ministry of Fisheries and Aquaculture must vigilantly supervise the collection of ecotourism revenue at the Bosomtwe Lake so that some of the funds would be utilized for developmental projects including job creation avenues in the Abono community. This would motivate the residents to support all the actions that would ensure the health of the Bosomtwe Lake and its aquatic biodiversity.

6. The Ministries of Fisheries and Aquaculture, the Forestry Commission, The Ministry of Mines and Energy and the Environmental Protection Agency must liaise to regulate and maintain the strict adherence of farming, fishing, hunting, mining and constructional rules and regulations at the surrounding of the lake. The culprits must be fined and arrested to serve as a deterrent to others not to engage in any form of activity that would be detrimental to the aquatic biodiversity in the lake. All structures and farmlands that illegally occupy the territories of the lake must be demolished and ceased from functioning. These ministries and agencies must also ensure that proper waste management systems that are friendly to the health of the lake, its aquatic biodiversity and environs are maintained by the nearby structures that are not within the catchment area of the Bosomtwe Lake.

7. The Forestry Commission and Environmental Protection Agency must support and intensify the communal labour activities in the Abono community by supplying them with the needed logistics such as refuse containers, brushes, and other cleaning and sanitation tools and materials. Also, they must assist the people to use such platforms for re-planting native flora and mangrove species at the degraded sections of the lake.

8. Some of the local people must be employed as guards at the Bosomtwe Lake so that they can oversee the undertaking of activities at all times (24/7) to report any form of environmental deleterious activity to the Management Council so the culprits would be punished promptly.

9. The Ministry of Fisheries and Aquaculture must organize training sessions for the fishermen at the Bosomtwe Lake to educate them with modern, safe fishing practices while supporting the development of their traditional gadgets for fishing to meet modern standards of fishing.

ACKNOWLEDGEMENTS

The researcher would like to thank the chiefs and Traditional Council and Management Council of the Bosomtwe Lake as well the all the residents, especially the fishermen in the Abono community who assisted the researcher with the needed data for the study. Special thanks go to the head of the Bosomtwe Range Reserve and the conservationists working in the department for their support in the research. I sincerely thank my research assistants, Mrs. Addai, Mr. Amponsah, and Mr. Adjei for assisting the researcher in conducting the numerous personal and Focus Group Discussion interviews as well as the direct observation of the state of the aquatic biodiversity in the Bosomtwe Lake.

REFERENCES

1. Abreu A. D., Salinas A. H. and Clusener-Godt M., 2016– Sustainable management of the lake Bosomtwe in the Ashanti Region of Ghana, France: United Nations Educational, Scientific and Cultural Organization, 46.
2. Adom D., 2016a – Asante indigenous knowledge systems: repositories of conservation ethics for Ghana's biodiversity, *Proceedings of the academic conference of Interdisciplinary Approach*, 7, 2, Uthman Danfodio University, Sokoto, Ptf I Hall, Sokoto, Sokoto State, Nigeria, 8-36.
3. Adom D., 2016b – Inclusion of local people and their cultural practices in biodiversity conservation: lessons from successful nations, *American Journal of Environmental Protection*, 4, 3, 67-78, doi: 10.12691/env-4-3-2.
4. Adom D., 2017 – Promoting cultural traditions, social inclusion and local community participation in environmental development schemes promoting cultural traditions, social inclusion and local community participation in environmental development schemes, *Global Journal of Science Frontier Research: Environment and Earth Science*, 17, 2.
5. Adom D., Dzakpasu P. E. and Adam S., 2017 – Cultural practices of local communities as a biodiversity managerial strategy for Ghana's environment: a retrospection of international conventions, *International Journal of Scientific Research*, 6, 5, 332-341.
6. Adu-Boahen K., Dei Leud A., Antwi, K. B. and Adu-Boahen, A. O., 2015 – Shoreline change detection of lake Bosomtwe, Ghana, evidence from historical and meteorological records, *Journal of Arts and Social Sciences*, 3, 1, 18-42.
7. Anim O. D., Li Y., Agadzi A. K. and Nkrumah P. N., 2013 – Environmental issues of lake Bosomtwe impact crater in Ghana (West Africa) and its impact on ecotourism potential, *International Journal of Scientific and Engineering Research*, 4, 1.
8. Asamoah E., Nketia K. A., Sadick A., Gyambibi D. A., Forkuo E. K., Ayer J. and Adjei E. O., 2015 – Water quality assessment of lake Bosomtwe for irrigation purpose, Ghana, *International Journal of Agriculture and Crop Sciences*, 8, 3, 366-372.
9. Bradley C., Emmet D. J., and Gonzalez A., 2012 – Biodiversity loss and its impact on Humanity, *Nature*, 486, 7401, doi:10.1038/nature11148, PMID 22678280, 59-67.
10. Dassah A. L. and Agbo N., n. d. – Lake Bosomtwe fisheries: the threats to biodiversity and livelihoods in the Bosomtwe Basin, KNUSTSPACE: Department of Freshwater Fisheries and Watershed Management, 1-6.
11. Denzin N. K. and Lincoln, Y. S., 1994 – Introduction: entering the field of qualitative research, in Denzin N. K. and Lincoln Y. S., (eds) *Handbook of qualitative research*, Thousand Oaks: Sage Publications, 1-17.
12. Fade S., 2004 – Using interpretive phenomenological analysis for public health nutrition and dietetic research: A practical guide, *Proceedings of the Nutrition Society*, 63, 647-653.
13. Fisheries Regulations of Ghana, 2010 – Ministry of Fisheries and Aquaculture: Government of Ghana, 46.
14. Fraenkel J., Wallen N. and Hyun H., 2012 – How to design and evaluate research in Education, (8th edition), New York: Mc Graw-Hill Companies, 707.
15. Gorde S. P. and Jadhav M. V., 2013 – Assessment of water quality parameters: a review, *Journal of Engineering Research and Applications*, 3, 6, 2029-2035.
16. Harden G., 1968 – The tragedy of the commons, *Science*, 162, 1, 239-257.
17. Helfrich L. A., Neves R. J., Parkhurst J., 2009 – Sustaining America's aquatic biodiversity, What is biodiversity; Why is it important? Communications and Marketing, College of Agriculture and Life Sciences, Virginia Polytechnic Institute and State University, retrieved from <http://www.ext.vt.edu> (accessed 3/6/2016).
18. Hogan R., 2010 – Protected areas for a living planet, W.W.F. International, Nagoya, Japan, 1-2.

19. Jones W. B., Bacon M. and Hastings D. A., 1981 – The Lake Bosomtwe Impact Crater, *Ghana Geological Society of America Bulletin*, 8, 1-392.
20. Khoshnood Z., 2017 – Effects of environmental pollution on fish: a short review, *Transylvanian Review of Systematical and Ecological Research – The Wetlands Diversity*, 19.1, 49-60.
21. Kumekpor K. B., 2002 – *Research Methods and Techniques of Social Research*, Ghana: SonLife Printing Press and Services, 304.
22. Lamptey E., 2015 – Eco-Functional Benthic Biodiversity Assemblage Patterns in the Guinea Current Large Marine Ecosystem, *Physical and Life Science Series*, 2, Department of Marine and Fisheries Sciences Reader, University of Ghana, 314.
23. Leedy P. D. and Ormrod J. E., 2010 – *Practical Research: Planning and Design* (9th edition), Upper Saddle River, New Jersey: Pearson Education, Inc., 67.
24. Lewis J. L. and Sheppard S. R. J., 2006 – Culture and Communication: Can Landscape Visualization Improve Forest Management Consultation with Indigenous Communities? *Landscape and Urban Planning*, 77, 291-313.
25. Mohammed A. K., 2014 – Tourism Development Policy versus Practice in Ghana: The Case of Lake Bosomtwe Basin, *European Scientific Journal*, 10, 7, 27.
26. Moon P. A. and Mason D., 1965 – The Geology of the ¼ Field Sheets 129 and 131, Bompata S. W. and N. W., *Ghana Geological Survey Bulletin*, 31, 1-51.
27. Nketia K. A., Asamoah E., Sadick A., Asenso-Gyambibi D. and Forkuo E. K., 2016 – Assessment of Water Quality of Lake Bosomtwe for Recreational Purposes, *International Research Journal of Agricultural and Food Sciences*, 1, 5, 108-114.
28. Orighabor B. J., 2016 – Impact of Human Activities on Biodiversity in Nigerian Aquatic Ecosystems, *Science International*, 4, 12-20.
29. Otu M. K., 2010 – The Origin, Transformation and Deposition of Sediments in Lake Bosomtwe (Ghana/West Africa). Doctoral Dissertation, University of Waterloo, Ontario, Canada, 200.
30. Pietkiewicz I. and Smith J. A., 2014 – A Practical Guide to Using Interpretative Phenomenological Analysis in Qualitative Research Psychology, *Psychological Journal*, 20, 1, 2014, 7-14.
31. Pope C., Ziebland S. and Mays N., 2000 – Qualitative Research: Analysing Qualitative Data, *British Medical Journal*, 320, 114-116.
32. Shah A., 2014 – *World's Biodiversity Crisis*, <http://www.globalissues.org>, (accessed 2015 October 3), 1-3.
33. Smith E. A. and Wishnie M., 2000 – Conservation and Subsistence in Small-Scale Societies, *Annual Reviews Anthropology*, 29, <http://dx.doi.org/10.1146/annurev.anthro.29.1.493>, 493-524.
34. Smith J. A. and Osborn M., 2008 – Interpretive Phenomenological Analysis, in Smith J. (ed.), *Qualitative Psychology, A Practical Guide to Research Methods*, London: SAGE, 53-80.
35. Whyte S. A., 1975 – Distribution, Tropic Relationship and Breeding Habits of the Fish Populations in a Tropical Lake Basin (Lake Bosomtwe- Ghana), *Journal of Zoology London*, 177, 25-26.
36. Wilder B. T., O'meara C., Monti L. and Nabhan G. P., 2016 – The Importance of Indigenous Knowledge in Curbing the Loss of Language and Biodiversity, *Bioscience*, 66, 449-509, doi:10.1093/biosci/biw026, 66, 6.
37. W.W.F., 2016 – Living Planet Report. Retrieved from <http://www.wwf.panda.org> (accessed 12/7/2016), 1-2.